



INSTALLATION & MAINTENANCE MANUAL

**HBN SERIES**

## GENERAL INSTRUCTIONS

**These instructions should be read carefully and retained after installation by the end user for future reference and maintenance.**

**These instructions should be used to aid installation of the following products:  
HBN150 / HBN200**

## SAFETY

- This product must be installed in accordance with the latest edition of the IEE Wiring Regulations (BS7671) and current Building Regulations. If in any doubt, consult a qualified electrician
- Please isolate mains prior to installation or maintenance
- Check the total load on the circuit (including when this luminaire is fitted) does not exceed the rating of the circuit cable, fuse or circuit breaker
- Please note the IP (Ingress Protection) rating of this luminaire when deciding the location for installation
- This product is for indoor use only
- This product is Class I and must be earthed
- This product is IP65 rated

## INSTALLATION

- Provide power to the required point of installation. Suitable IP rated junction boxes should be used where required

### **Suspension mounting**

- To suspend the fitting, screw the mounting hoop into the top of the luminaire and secure with the screw provided (see Fig. 1)

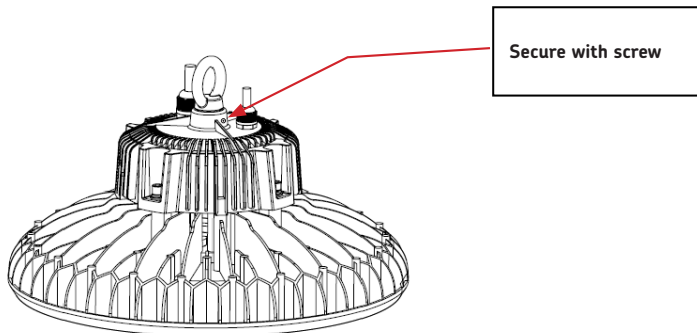

**Fig. 1**

### **Bracket mounting**

- Using the bracket as a template, mark the location of the fixing holes, drill 2 x 10mm holes ensuring not to infringe with any joists, gas/water pipes or electrical cables
- Using a hammer, tap the expansion bolts into the 10mm fixing holes (see Fig. 2)

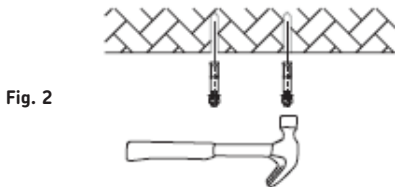

**Fig. 2**

- Tighten expansion bolt nuts but allow enough space for the bracket to mount
- Remove the driver housing via the 4 Allen screws (see Fig. 3)

Fig. 3

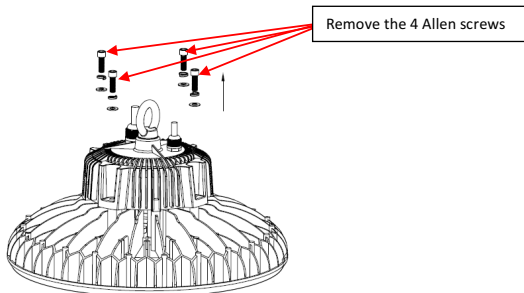

- Align the mounting bracket with 2 of the driver housing screw pillars (see Fig. 4)

Fig. 4

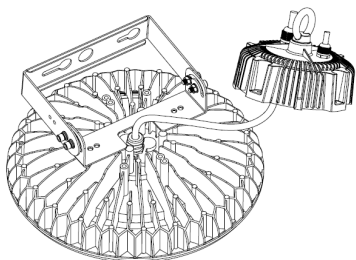

- Position the driver housing over the bracket ensuring all Allen screw holes are correctly aligned and fasten down the 4 Allen screws (see Fig. 5)

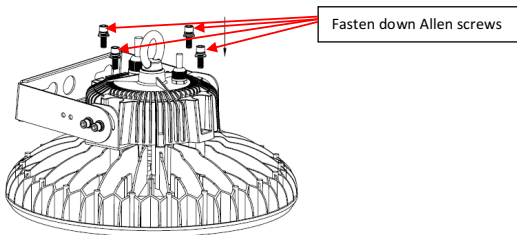

Fig. 5

- Lift the fitting up to the expansion bolts and slide into the bracket (see Fig. 6)

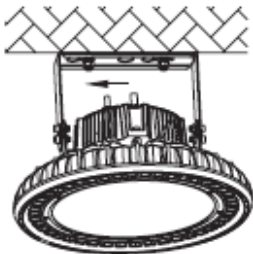

Fig. 6

- Tighten the two expansion bolts to secure the luminaire to the surface
- Ensuring correct polarity is observed, carefully wire as shown in Figs. 7-9. Suitable IP rated junction boxes should be used where required

### Wiring Schemes

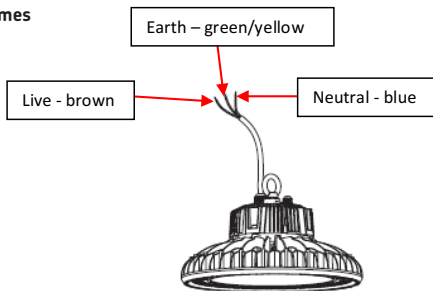

Fig. 7

To wire the luminaire with a 1-10V dimmer (not supplied) see Fig. 8

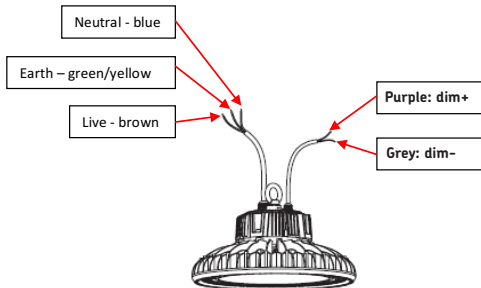

Fig. 8

To wire the luminaire with microwave sensor HBNS see Fig. 9

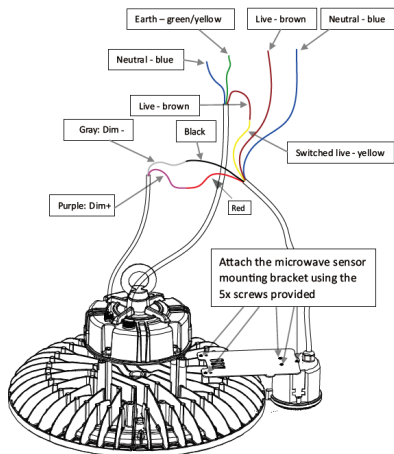

Fig. 9

- Switch on and check for correct operation

## WARNING

This luminaire must be disconnected from the circuit if subjected to any high voltage or insulation resistance testing. Irreparable damage will occur if this instruction is not followed. Ensure correct fixtures are used for the surface to which the luminaire is fixed

## GENERAL

The light source of this luminaire is not replaceable; when the light source reaches its end of life the whole luminaire should be replaced.

Be aware that these products may require an MCB upgrade to a type C due to high inrush currents  
Clean with a soft dry cloth only, do not use aggressive cleaning products or solvents which may damage the product

Do not use any source of high pressure washers to maintain or clean this luminaire

This product is dimmable via a 1-10V dimmer

This product should be recycled in the correct manner when it reaches the end of its life. Check local authorities for where facilities exist

## WARRANTY

This product has a warranty of 5 years from date of purchase. Failure to install this product in accordance with the current edition of the IEE Wiring Regulations (BS7671), improper use, or removal of the batch codes will invalidate the warranty. If this product should fail within its warranty period, it should be returned to the place of purchase for a free of charge replacement. ML Accessories does not accept responsibility for any installation costs associated with the replacement product. Your statutory rights are not affected. ML Accessories reserve the right to alter product specification without prior notice.



ML Accessories Limited LUS 4LT  
[www.mlaccessories.co.uk](http://www.mlaccessories.co.uk)

## INTERNATIONAL CONTACT DETAILS



DCAUG21\_V3