

COMBI 607 LG

Junction box, polypropylene

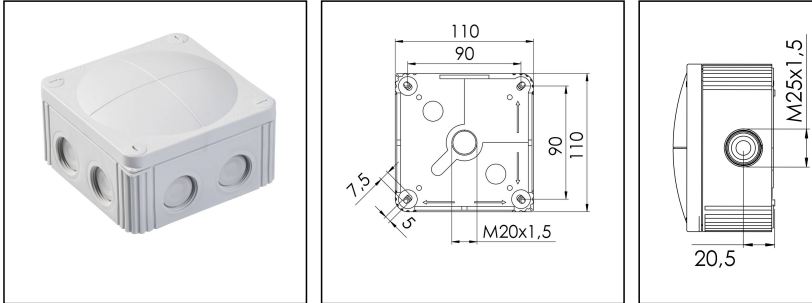

Products may differ in size, colour and appearance to those shown. If you require further information or customisation, please contact us directly.



Material	Polypropylene
Material sealing gasket	TPE
Temp. range min	-30 °C
Temp. range max	100 °C
Temperatures during install.	-5 °C - 60 °C
Protection class	IP66 / IP67
Glow wire test	750 °C
Voltage	690 V
Rated cross section	6 mm ²
Fixing	4 internal openings
Ø cable diameter min	5,2 mm
Ø cable diameter max	17 mm
External dimensions LxWxH	110 x 110 x 66mm
Using for cable gland	
Product Color	RAL 7035
WISKA-Order no.	10060531
Type	COMBI 607 LG
Packing unit	3
EAN number	4007685605311
Tariff number	39269097
ETIM-Classification	EC002600

Remarks:

IP66: using the membrane entry

IP67: using the threaded entry together with ESKV cable gland

Your Contact:

WISKA UK Ltd.

Unit 7, Hurling Way · St. Columb Major Business Park · TR9 6SX, St. Columb Major, Cornwall · Great Britain

☎ +44-12-08816062 · 📠 +44-12-08816708

info@wiska.co.uk · www.wiska.co.uk

Equipment:

- 7 M25 threaded membrane entries
- 3 membrane cable entries through rear
- 4 captive cover screws

Mounting:

- 4 internal openings outside of the sealing area

Recommended accessories

DIN Rail Kit - COMBI 607/TS 35	10060361
MP-L Mounting plate large COMBI / WHK	10105775
External mounting - COMBI LG	10108836
SP-HKT 607 Terminal block	22000407

20.04.2022

Your Contact:

WISKA UK Ltd.

Unit 7, Hurling Way · St. Columb Major Business Park · TR9 6SX, St. Columb Major, Cornwall · Great Britain

☎ +44-12-08816062 · 📠 +44-12-08816708

info@wiska.co.uk · www.wiska.co.uk

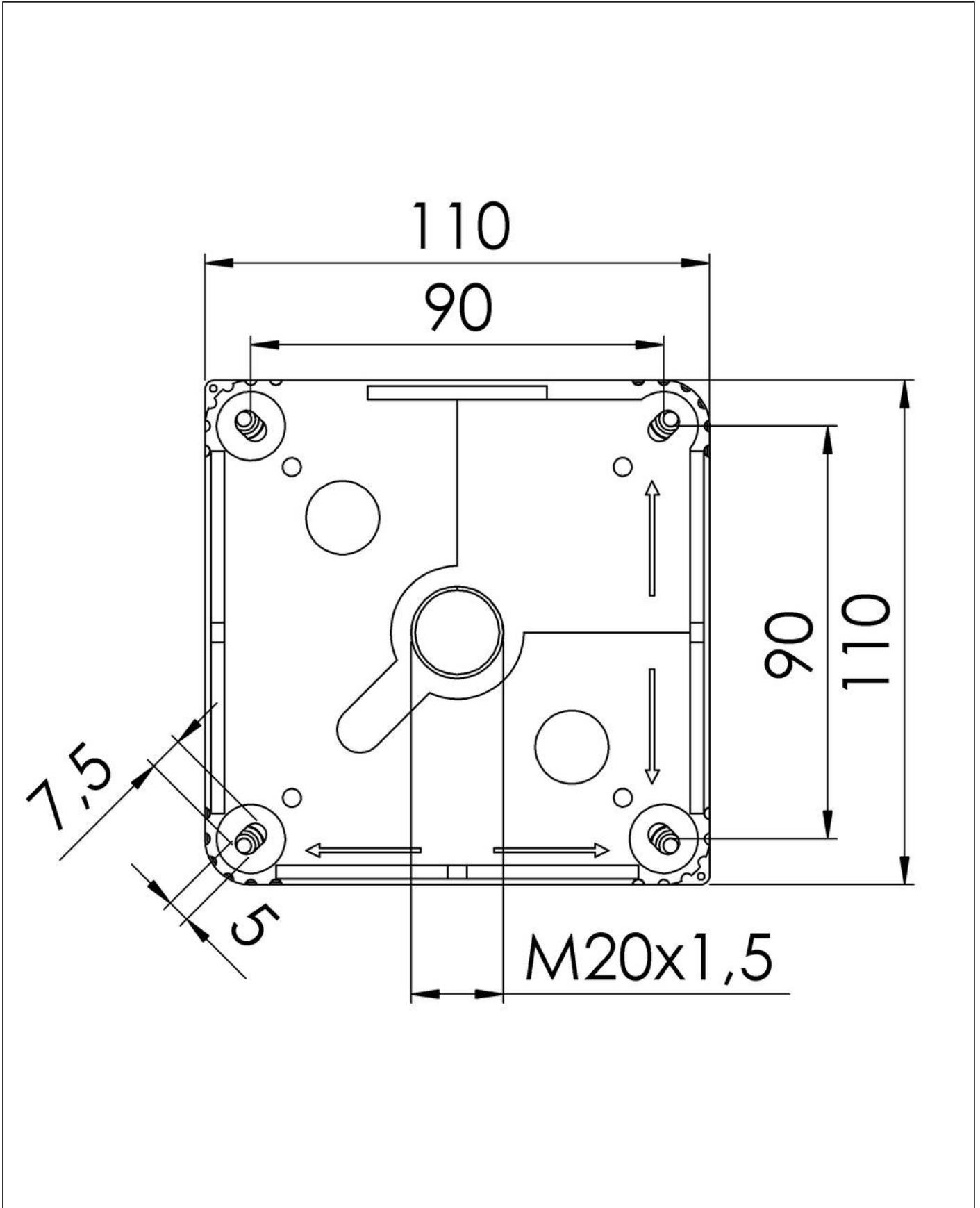

Your Contact:

WISKA UK Ltd.

Unit 7, Hurling Way · St. Columb Major Business Park · TR9 6SX, St. Columb Major, Cornwall · Great Britain

☎ +44-12-08816062 · 📠 +44-12-08816708

info@wiska.co.uk · www.wiska.co.uk

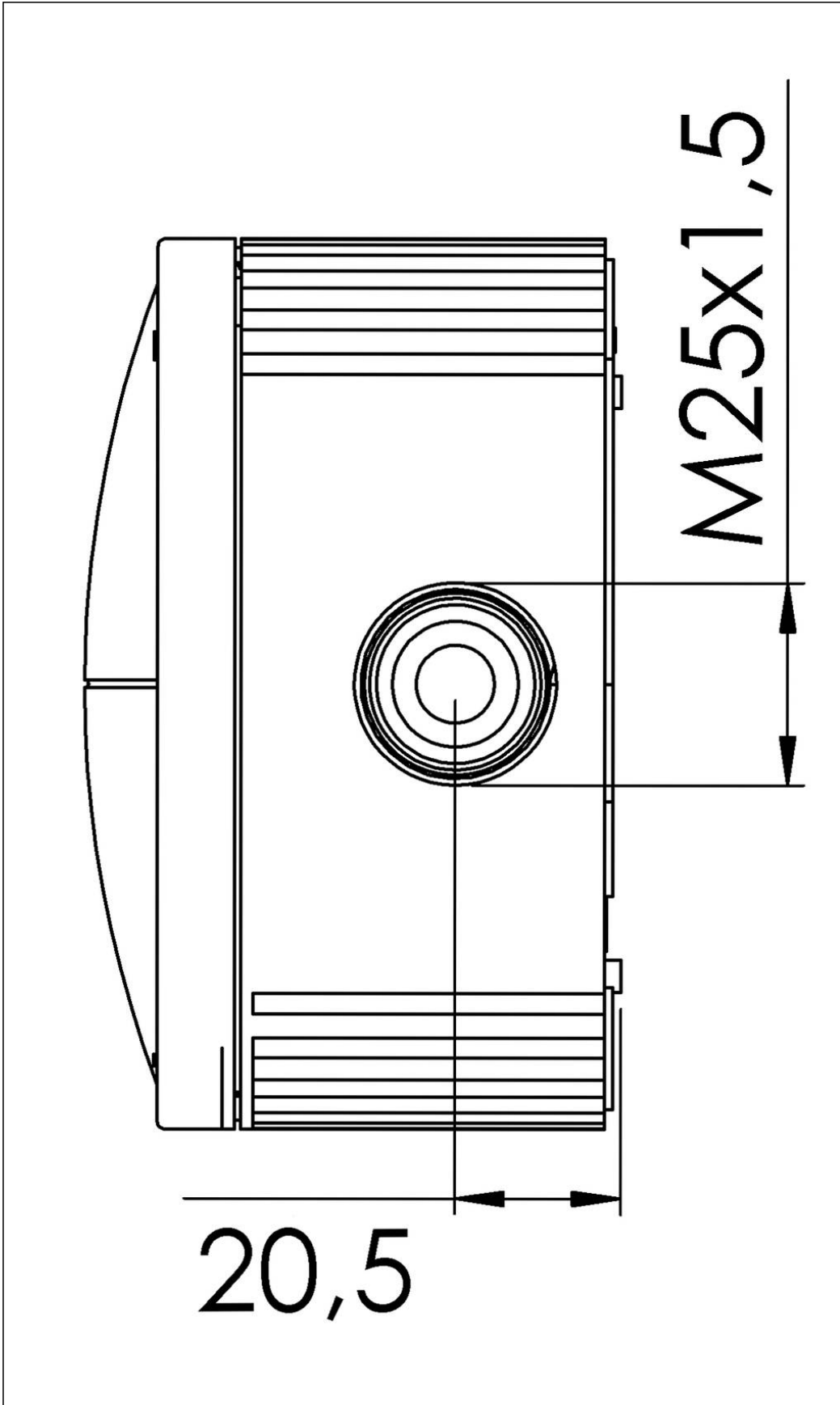

Your Contact:

WISKA UK Ltd.

Unit 7, Hurling Way · St. Columb Major Business Park · TR9 6SX, St. Columb Major, Cornwall · Great Britain

☎ +44-12-08816062 · 📠 +44-12-08816708

info@wiska.co.uk · www.wiska.co.uk