

COMBI 304 BK

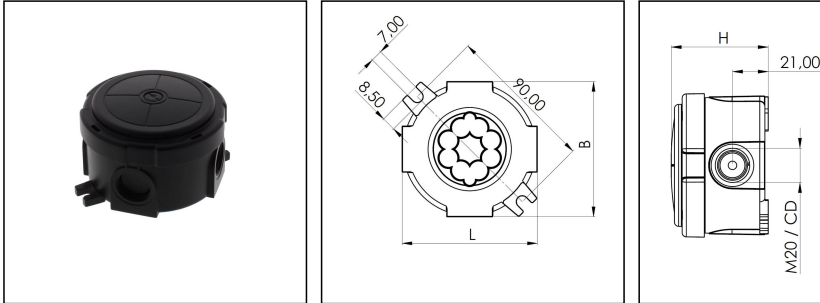

Products may differ in size, colour and appearance to those shown. If you require further information or customisation, please contact us directly.



Material	Polypropylene
Material sealing gasket	TPE
Temp. range min	-30 °C
Temp. range max	100 °C
Temperatures during install.	-5 °C - 60 °C
Protection class	IP66 / IP67
Glow wire test	750 °C
Voltage	400 V
Rated cross section	2,5 mm ²
Fixing	2 external mounting feet
Ø cable diameter min	3 mm
Ø cable diameter max	12 mm
External dimensions LxWxH	Ø 82 x 57mm
Type of cable gland	M 20 x 1,5
Product Color	RAL 9005
WISKA-Order no.	10110630
Type	COMBI 304 BK
Packing unit	5
EAN number	4007686257779
Tariff number	39269097
ETIM-Classification	EC002600

Remarks:

IP66: using the membrane entry

IP67: using the threaded entry together with ESKV cable gland

Your Contact:

WISKA UK Ltd.

Unit 7, Hurling Way · St. Columb Major Business Park · TR9 6SX, St. Columb Major, Cornwall · Great Britain

☎ +44-12-08816062 · 📠 +44-12-08816708

info@wiska.co.uk · www.wiska.co.uk

Equipment:

- 4 M20 threaded membrane entries

Recommended accessories

SP-KT-W 221/CSM-3x221-413	22001114
SP-KT-W 221/CSM	22001115

20.04.2022

Your Contact:

WISKA UK Ltd.

Unit 7, Hurling Way · St. Columb Major Business Park · TR9 6SX, St. Columb Major, Cornwall · Great Britain

☎ +44-12-08816062 · 📠 +44-12-08816708

info@wiska.co.uk · www.wiska.co.uk

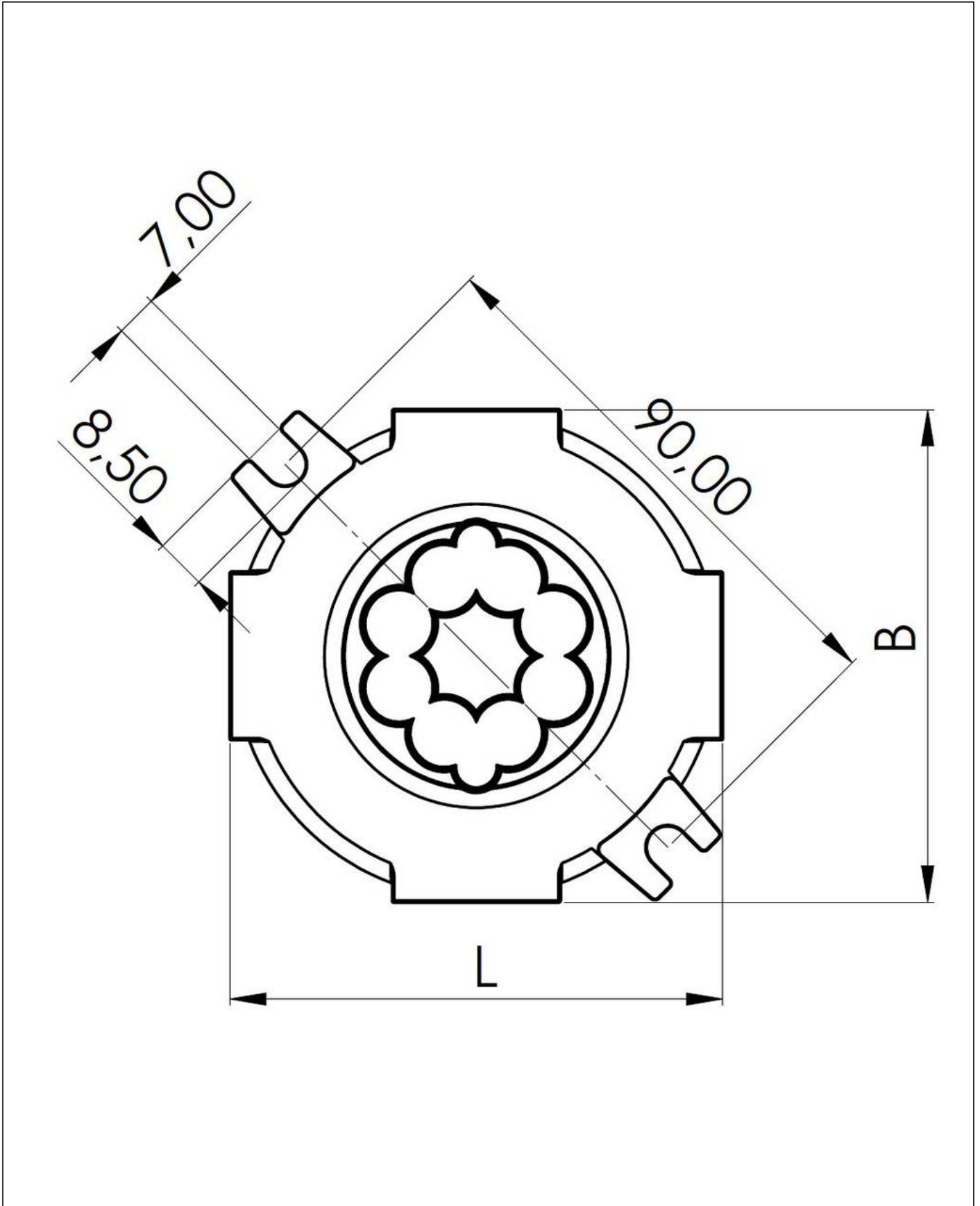

Your Contact:

WISKA UK Ltd.

Unit 7, Hurling Way · St. Columb Major Business Park · TR9 6SX, St. Columb Major, Cornwall · Great Britain

☎ +44-12-08816062 · 📠 +44-12-08816708

info@wiska.co.uk · www.wiska.co.uk

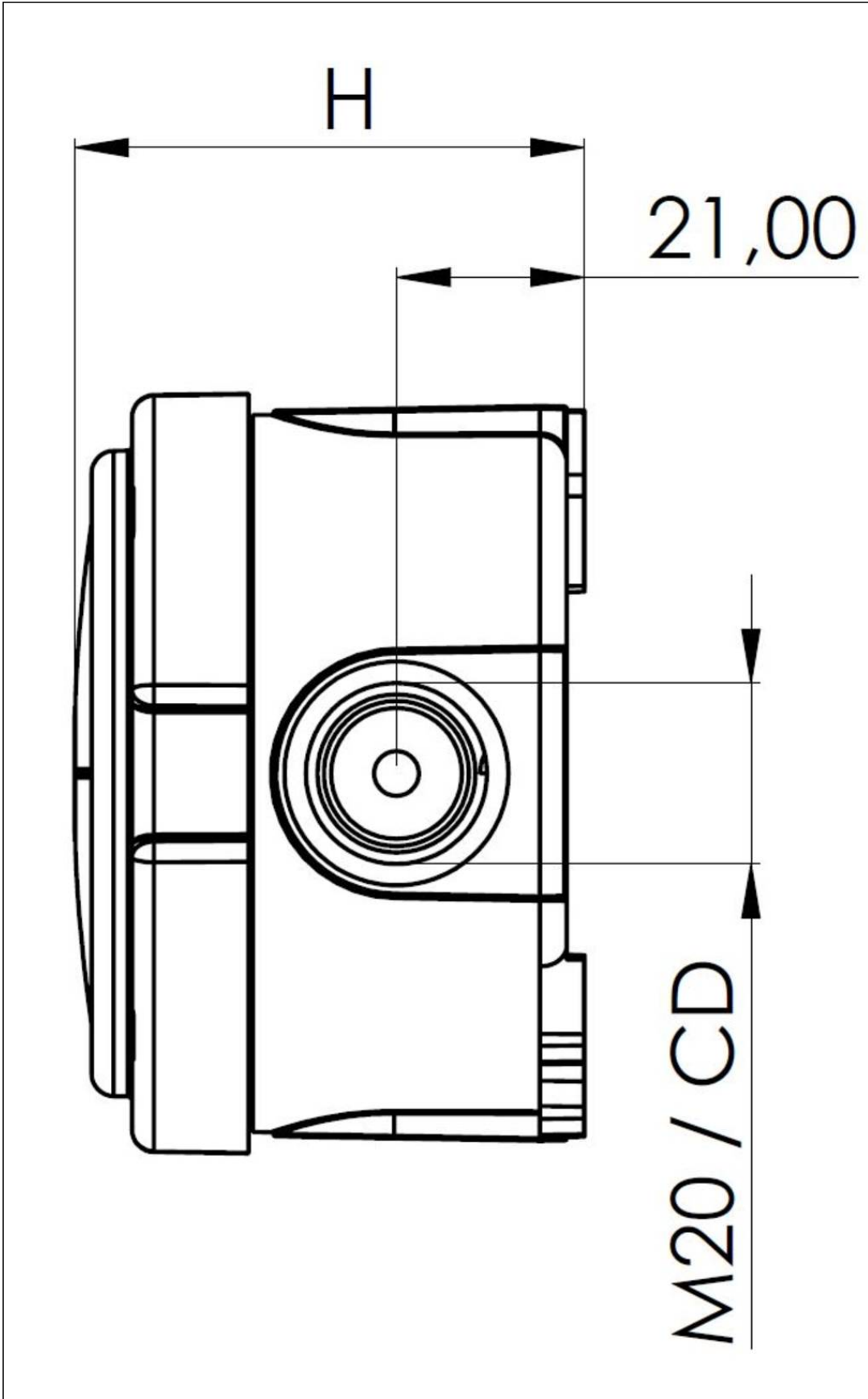

Your Contact:

WISKA UK Ltd.

Unit 7, Hurling Way · St. Columb Major Business Park · TR9 6SX, St. Columb Major, Cornwall · Great Britain

☎ +44-12-08816062 · 📠 +44-12-08816708

info@wiska.co.uk · www.wiska.co.uk