

KIRA

7288901118

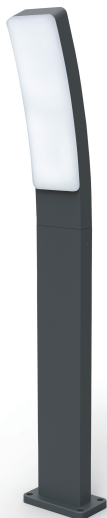

User manual
Bedienungsanleitung
Mode d'emploi
Handleiding
Manuale
Manual del usuario
Használati utasítás
Instrukcja obsługi



LUTEC

Incl.

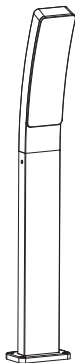

× 4



× 4

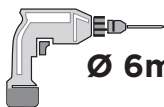

Ø 6mm



Installation

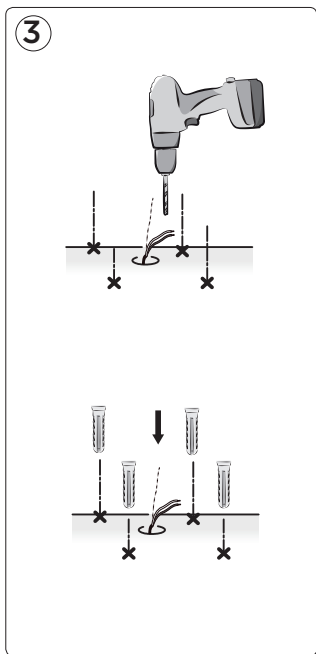
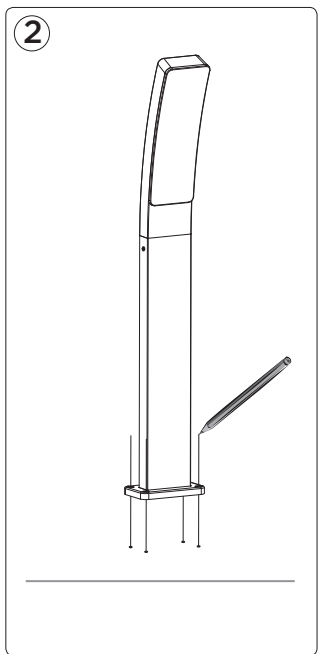
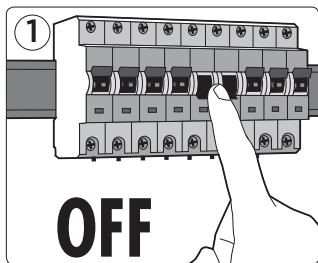

4

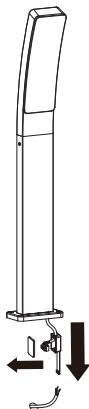

5

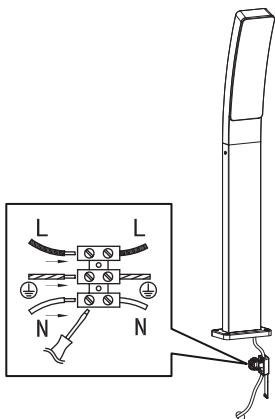

6

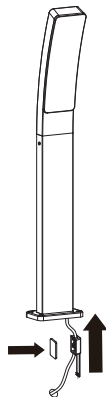

7

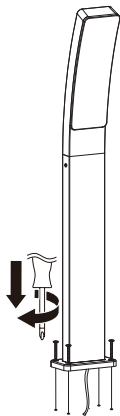

Download the free TuyaSmart app



TuyaSmart

- Download the APP.
- Télécharger l'application.
- Laden Sie die APP herunter.
- Scaricare l'APP.
- Descargar la APP.
- Download de APP.
- Töltse le az applikációt.
- Pobierz aplikację.

Sign up & log in



①

Register
Registrieren
S'inscrire
Registreeer
Registrati
Registro
Regisztráció
Zarejestrować

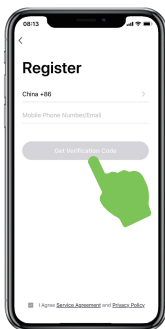

②

Get Verification Code
Bestätigungscode anfordern
Obtenir le code de vérification
Vraag verificatie code aan
Ottieni il codice di verifica
Obtén el código de verificación
Kérjen ellenőrző kódot
Uzyskaj kod weryfikacyjny



③

Enter Verification Code
Bestätigungscode eingeben
Entrez le code de vérification
Geef verificatie code in
Inserisci il codice di verifica
Ingresa el código de verificación
Adja meg a megerősítő kódot
Wpisz kod weryfikacyjny

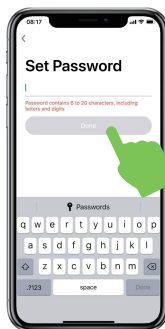

④

Set Password
Passwort festlegen
Définir le mot de passe
Stel wachtwoord in
Imposta la password
Configurar la clave
Állítsd be a jelszót
Ustaw hasło

Set-up

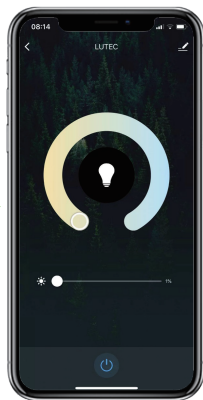
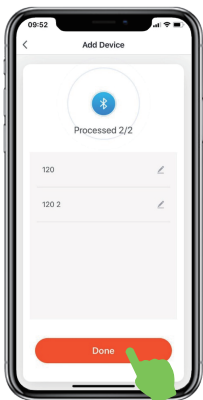
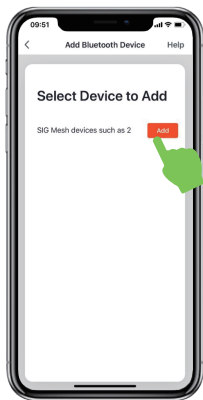
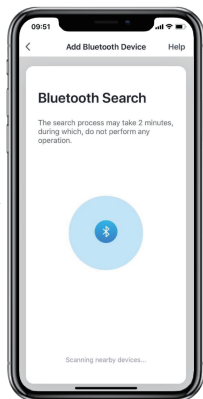
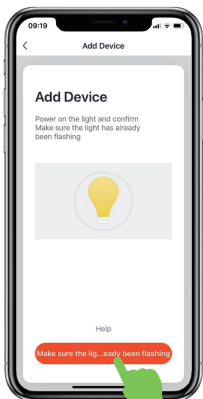
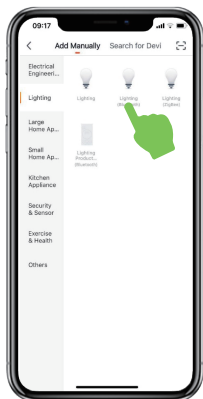

- ① Select device category ② Add device ③ Bluetooth search ④ Select device to add
⑤ Confirm selection ⑥ Ready for use

- ① Gerätekategorie auswählen ② Gerät hinzufügen ③ Bluetooth-Suche ④ Gerät zum Hinzufügen auswählen ⑤ Auswahl bestätigen ⑥ Bereit!

- ① Sélectionner une catégorie d'appareil ② Ajouter un appareil ③ Recherche Bluetooth
④ Sélectionnez le périphérique à ajouter ⑤ Confirmer la sélection ⑥ Prêt à l'emploi

- ① Selecteer apparaatcategorie ② Voeg toestel toe ③ Bluetooth zoeken ④ Selecteer apparaat om toe te voegen ⑤ Selectie bevestigen ⑥ Klaar om te gebruiken

- ① Seleziona la categoria del dispositivo ② Aggiungi dispositivo ③ Ricerca Bluetooth
④ Seleziona il dispositivo da aggiungere ⑤ Conferma la selezione ⑥ Pronto per l'uso

- ① Seleccionar categoría de dispositivo ② Añadir dispositivo ③ Búsqueda de Bluetooth
④ Seleccionar dispositivo para agregar ⑤ Confirmar selección ⑥ Listo para usar

- ① Válassza ki az eszközkategóriát ② Eszköz hozzáadása ③ Bluetooth keresés
④ Válassza ki a hozzáadni kívánt eszközt ⑤ Erősítse meg a választást ⑥ Használatra kész

- ① Wybierz kategorię urządzenia ② Dodaj urządzenie ③ Wyszukiwanie Bluetooth
④ Wybierz urządzenie do dodania ⑤ Potwierdź wybór ⑥ Gotowy do użycia

Smart Settings



Smart settings
Intelligente Einstellungen
Paramètres intelligents
Slimme instellingen
Impostazioni intelligenti
Ajustes inteligentes
Intelligens beállítások
Inteligentne ustawienia

Personal Settings & Support

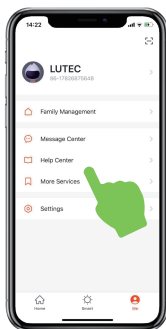

Personal settings & support
Persönliche Einstellungen & Support
Paramètres personnels et support
Persoonlijke instellingen & ondersteuning
Impostazioni e supporto personali
Configuraciones personales y soporte
Személyes beállítások és támogatás
Ustawienia osobiste i wsparcie

Bluetooth mesh technology

EASY CONNECTION



BLUETOOTH MESH TECHNOLOGY

Bluetooth® technology, the global standard for simple, secure wireless connectivity, now supports mesh networking.

The new mesh capability enables many-to-many device communications and is optimized for creating mid to large-scale device networks.

Bluetooth mesh allows you to solve more complex range and distance problems.

Die Bluetooth®-Technologie, der weltweite Standard für einfache und sichere drahtlose Verbindungen, unterstützt jetzt Mesh-Netzwerke.

Die neue Mesh-Funktion ermöglicht eine Many-to-Many-Verbindung und ist für mittelgroße bis große Netzwerke optimiert.

Mit Bluetooth®-Mesh können Sie komplexe Netzwerke über eine große physikalische Fläche und mit enormer Funkreichweite aufbauen.

La technologie Bluetooth®, le standard mondial pour une connectivité sans fil simple et sécurisée, prend désormais en charge le réseau maillé.

La nouvelle fonctionnalité de maillage permet des communications de plusieurs à plusieurs et est optimisée pour la création de réseaux de périphériques de moyenne à grande échelle. Le maillage Bluetooth vous permet de résoudre des problèmes plus complexes de gamme et de distance.

Bluetooth®-technologie, de wereldwijde standaard voor eenvoudige, veilige draadloze connectiviteit, ondersteunt nu mesh-netwerken.

De nieuwe mesh-mogelijkheid maakt apparaatcommunicatie van veel-op-veel mogelijk en is geoptimaliseerd voor het creëren van middelgrote tot grootschalige apparaatnetwerken. Met Bluetooth-mesh kunt u complexere bereik- en afstands problemen oplossen.

La tecnologia Bluetooth®, lo standard globale per la connettività wireless semplice e sicura, ora supporta la rete mesh.

La nuova funzionalità mesh consente la comunicazione tra molti dispositivi ed è ottimizzata per la creazione di reti di dispositivi di medie e grandi dimensioni.

La rete mesh Bluetooth consente di risolvere problemi di portata e di distanza più complessi. A tecnologia Bluetooth®, estándar global para una conectividad inalámbrica simple y segura, ahora admite redes en malla.

La nueva capacidad de malla permite comunicaciones en las que cada dispositivo pueden recibir y a la vez enviar información al dispositivo adyacente. De tal modo que el sistema está optimizado para crear redes de dispositivos de mediana a gran escala.

La malla Bluetooth le permite resolver problemas de distancia y alcance más complejos.

A Bluetooth® technológia, az egyszerű, biztonságos vezeték nélküli kapcsolat globális szabványa, most már támogatja a hálózatosítokat. (MESH)

Az új háló képesség több eszköz kommunikációját teszi lehetővé, valamint közép- és nagyméretű eszközhálózatok létrehozására van optimalizálva.

A Bluetooth háló lehetővé teszi a bonyolultabb távolsággal kapcsolatos problémák megoldását.

Technologia Bluetooth®, światowy standard prostej, bezpieczniejszej łączności bezprzewodowej, obsługuje teraz sieci typu mesh.

Nowa funkcja sieci umożliwia komunikację między wieloma urządzeniami (m: m) i jest zoptymalizowana do tworzenia średnich i dużych sieci urządzeń.

Siatka Bluetooth pozwala rozwiązać bardziej złożone problemy z zasięgiem i odległością.

Smartspeaker

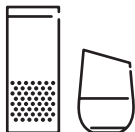

Connect first with gateway

Please connect first with gateway.

Bitte verbinden Sie sich zuerst mit dem Gateway.

Veuillez vous connecter d'abord avec la passerelle.

Maak eerst verbinding met gateway.

Connettiti prima con il gateway.

Conéctese primero con la puerta de enlace.

Először csatlakoztassa az átjárót.

Najpierw połącz się z bramą.



LUTEC Europe NV

Herentalsebaan 425
B-2160 Wommelgem - Belgium
+32 3 284 51 62
info@lutec-europe.com
www.lutec.com



www.lutec.com/services/global-network