

- Single gang PIR switch
- Replaces a standard light switch or dimmer
- Turns off automatically
- Turns on automatically
- Security mode
- Switches all lighting, heating and ventilation loads up to 10A

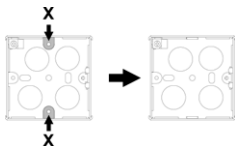

installation



Compatible with all BS4662 dimensions back boxes.

Remove top and bottom lugs if fitted.

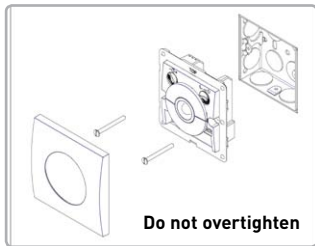

Location

It is important to locate the detector so that any occupants fall within the detection zone shown on the diagram.

Do not block the sensor with a door or other object.

Do not install above a radiator or other heat source.

Avoid direct sunlight entering the sensor.

This product should be installed in accordance with the current IEE wiring regulations. If in doubt consult a qualified electrician.

Use the extender if there is less than 25mm free space.

REMEMBER – put the wires through the extender before connecting.

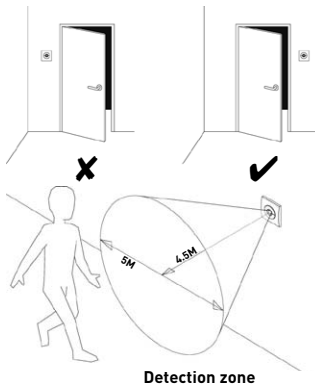
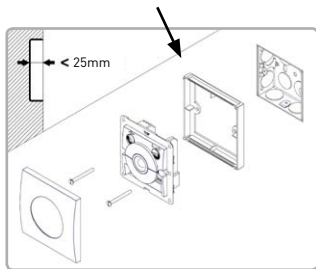

Detection zone

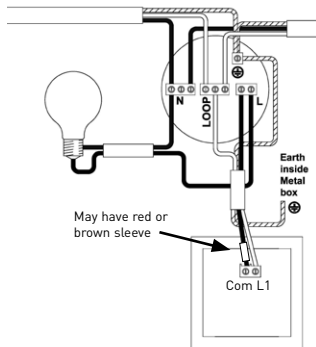

1 way switching

If the lights are controlled from one location only, wire as in the diagram.

Neutral		Black or Blue
Live		Red or Brown
Earth		Yellow Green
Strapper		Yellow or Grey

2 way switching

If more than one detector is required to switch the lighting (e.g. at the top and bottom of a staircase) they can be wired in parallel, as in the diagram.

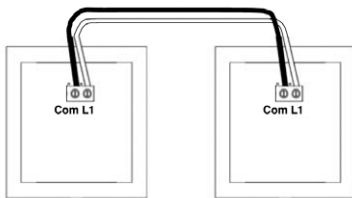

Remove front cover

Use a flathead screwdriver or similar to gently prise off the cover and replace with new one by snapping on to switch.

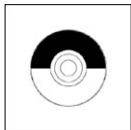
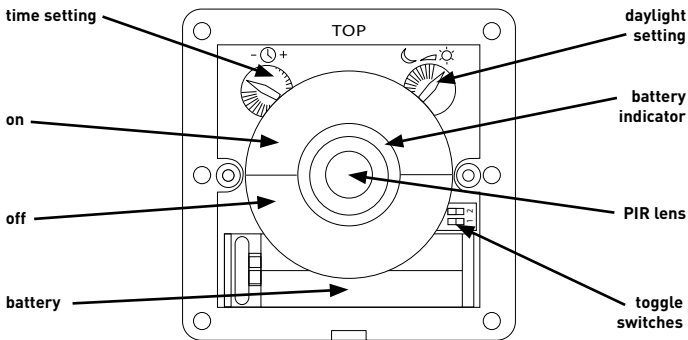
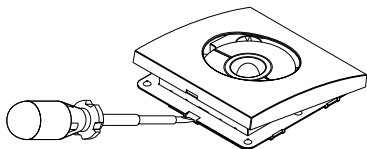

Short press - lights on

Press for more than 5 seconds to activate (see Activate section).

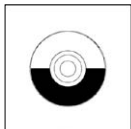

Short press - lights off

The lights will turn off whilst the area is occupied. The unit will reset to automatic operation after a period of time.

Press for more than 5 seconds to de-activate (see Activate section).



setup and suggested settings

Time setting 1min – 30min

The lights will turn off after the set time period. When movement is detected, the time period automatically restarts. Clockwise = longer time period.

Daylight setting

Use this setting to adjust the point at which daylight brightness automatically turns lights on. Clockwise = turn on with brighter daylight.

Auto on mode – in this mode lights remain off if there is enough natural daylight.

Toggle switch settings



Manual on (use on button):
Auto off (when nobody in the room, after time period).



Auto on (when somebody enters room):
Auto off (when nobody in the room, after time period).



Security mode activated.
See 'Security Mode' section (pg 6).



Security mode deactivated.

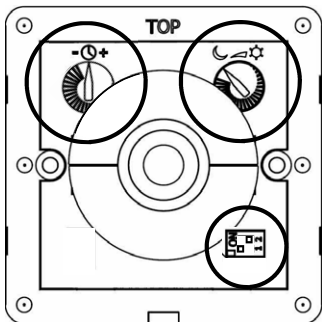

Corridor

The above settings turn light/s on when someone enters the corridor, turn light/s off when no movement is sensed for 20 minutes. Only turn light/s on if there is little or no daylight.

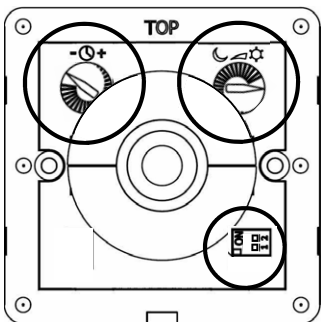

Bedroom

The above settings turn light/s on when the top button is pressed and turn light/s off when no movement is sensed for 10 minutes.



activate

- Before using, the unit needs to be activated
- Press and hold the top button for more than 5 seconds. The red LED will flash to indicate that it has activated and the unit will now operate
- If the unit is going to be out of use for prolonged periods (more than 6 months) it should be deactivated by repeating the procedure above with the bottom button. This will help to prolong battery life.



security mode

- Security mode can be turned on and off using the switches as shown in the 'setup' section
- When activated, security mode is used to switch on lighting when it gets dark, giving the impression a house is occupied
- When the unit senses that it is dark outside, the lights will automatically switch on for a period of 2 hours then switch off.



batteries

- The internal battery should last in excess of 3 years, dependent on usage
- When it needs replacing, a red LED will flash on the front of the unit
- Follow the steps opposite to replace the battery
- Use only good quality, 9V alkaline batteries type PP3
- Once the battery has been changed activate the unit as described in the 'activate' section.

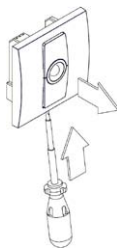

1. Remove front cover

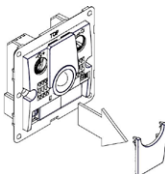

2. Remove switch cover

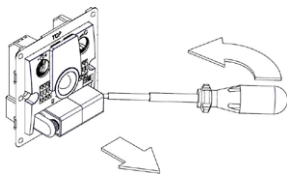

3. Lever out battery

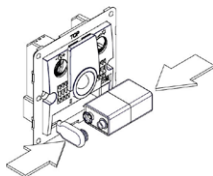

4. Replace battery

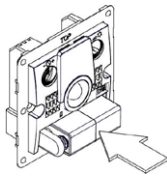

5. Push into holder

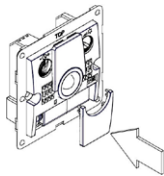

6. Replace switch cover

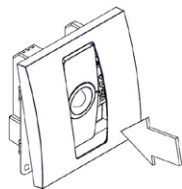

7. Replace front cover

8. Activate



troubleshooting

Lights turn off even though room is occupied

- Check location of sensor – see detection diagram
- Increase timing, typically 15 minutes for a living area.

Lights never turn off

- The lights will only turn off after no movement is detected for the time period. Is the time period set too long?



ratings



EMS 534520



FM 45789



Voltage 230VAC +/- 10%

Frequency 50Hz

Temperature 0°C to 35°C

Power 10A

Compliance BS EN60669-2-1 &
BS EN55015

EU registered design no. 000638069-0003,
000638069-0004



CP Electronics
Brent Crescent
London
NW10 7XR

T: + 44 (0)333 900 0671

F: + 44 (0)333 900 0674

www.cpelectronics.co.uk
enquiry@cpelectronics.co.uk