

RAK-LINK Instruction Manual

For programming information: [Wired system Programming Guide](#)

For further installation information: [Wired RAK Application Sheet](#)



What is the RAK-LINK?

The RAK-LINK is a required element of any wired system.

The RAK-LINK powers the wired network and also provides a link between the keypads and RAK dimmers.

Up to 32 RAK circuits can be used per RAK-LINK. These 32 circuits can be designated in any combination of RAK8s and RAK4s.

The RAK-LINK supports up to approximately 40 wired devices communication devices in a typical installation of 1000m of data cable. "Wired communication devices" refers to WCMs (keypads), WAPIR (motion sensor) etc.

[For a more exact calculation of power requirements please refer to "RAK-LINK diagnostics" application sheet.](#)

Typical Wired Installation layout:

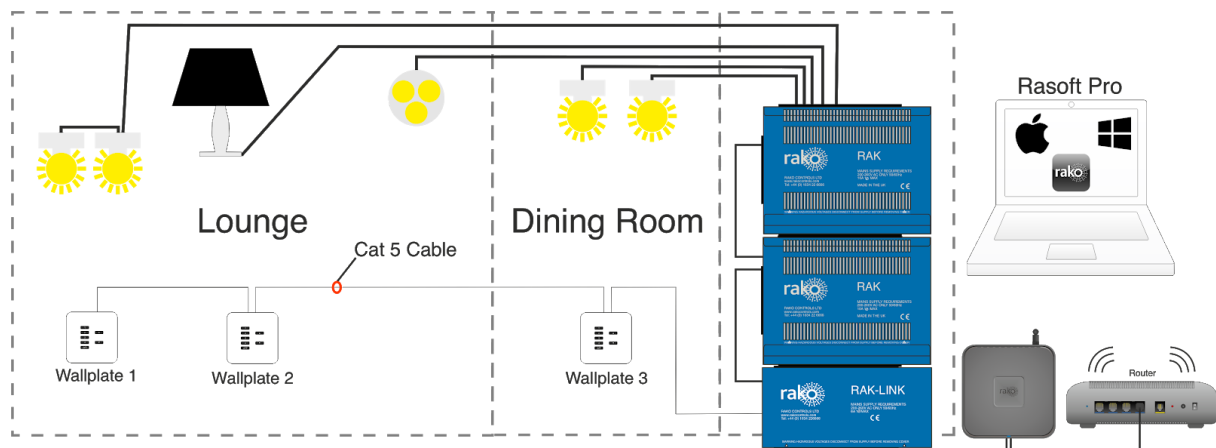



Installation of the RAK-LINK

The connections to the RAK-LINK, as shown below are:

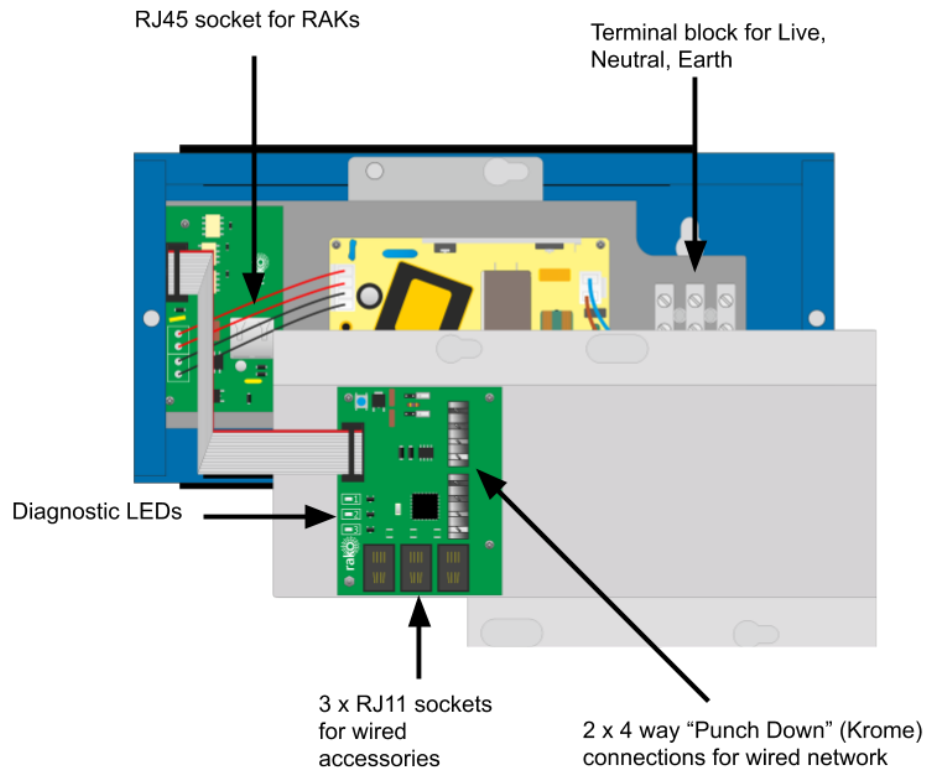
- 1) Mains AC connection to power supply
- 2) RJ45 patch lead to RAK stacks
- 3) Krone connector punchdowns and RJ11 sockets to wired network
- 4) Optional 3 x RJ11 sockets for wired accessories

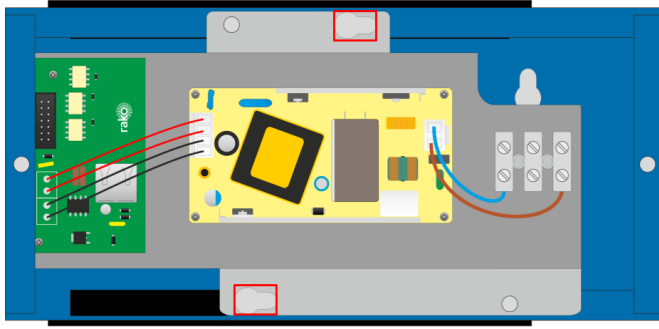
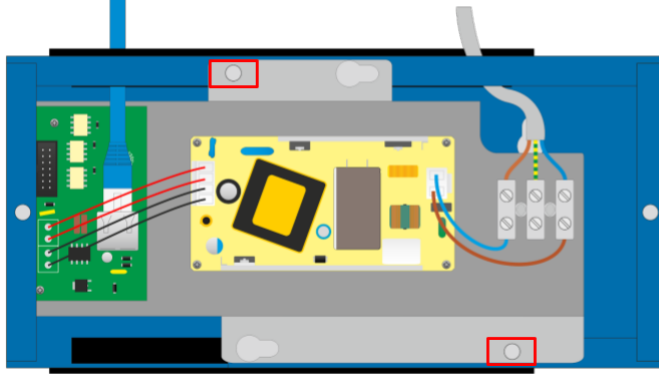
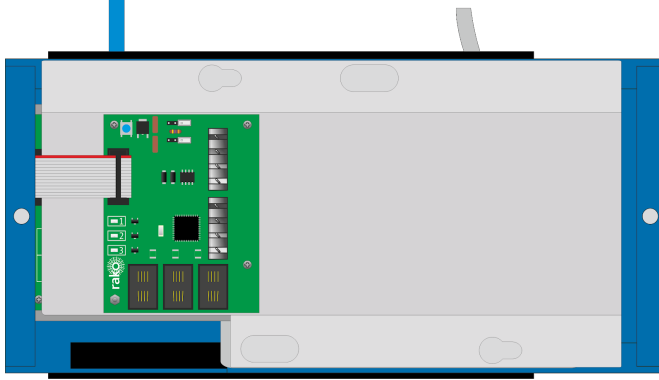
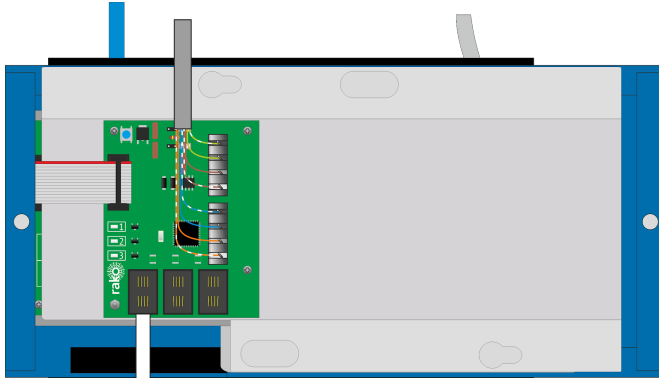

<p>Step 1</p>		<p>Remove lid.</p> <p>Remove plastic knockouts to allow cables to pass in and out of RAK-LINK.</p>
<p>Step 2</p>		<p>Slot the RAK-LINK housing into the RAK metal work</p> <p>Screw RAK-LINK to wall and prepare mains supply cable.</p>

<p>Step 3</p>		<p>Remove the top tray by disconnecting the ribbon cable and screws</p> <p>Fix the lower tray into the wall mounted metal housing using the screws indicated in the diagram.</p>
<p>Step 4</p>		<p>Wire the mains supply into the terminal block.</p> <p>Insert the RJ45 cable that links the RAK-LINK to a stack of RAKs.</p> <p>Prepare two remaining screws to be slotted into top tray</p>
<p>Step 5</p>		<p>Reattach the ribbon cable between the top and bottom board</p> <p>Slot the top tray into the bottom tray and screw down</p>
<p>Step 6</p>		<p>Punchdown the CAT5 to wired network to complete installation.</p> <p>If required plug devices (for example HUB or Bridges) into the RJ11 ports</p>

Terminating the RAK-LINK

The final step in the installation process is to terminate the RAK-LINK. The termination that is required depends on the nature of the installation and the position of the RAK-LINK within the system.

Termination Jumper settings:

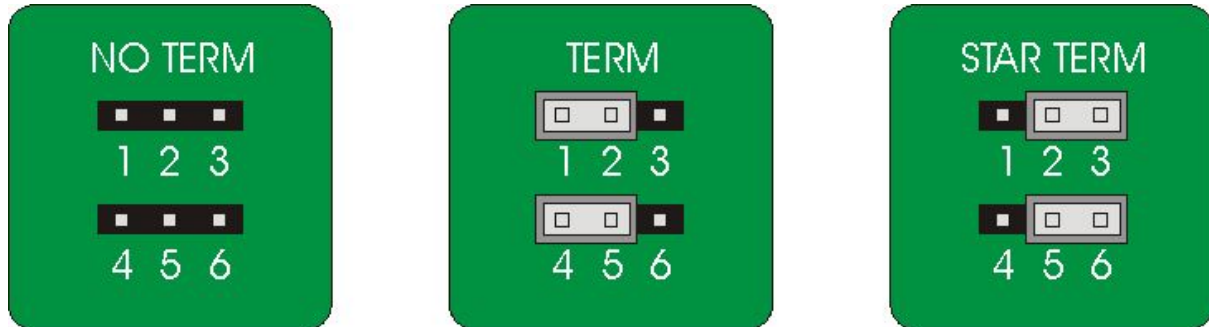

No Term - Both Jumpers removed

Used when the RAK-LINK is not at the end of line. This is usually identifiable by two cables being punched down to the RAK-LINK.

Term - Jumper fitted across 1+2 & 4+5

Used when the RAK-LINK is end of line in a daisy chain configuration (such as the RAK-LINK shown in "Typical Wired Installation layout" on page one).

Star Term - Jumper fitted across 2+3 & 5+6

Used when the RAK-LINK is end of line in a STAR wire configuration.

Programming the RAK-LINK

The RAK-LINK is programmed using the Rasoft pro programming software. A WK-HUB or WA/WTC-Bridge is required for any programming of a wired system.

[For more information on how to programme a RAK-LINK please refer to "Wired System Setup Guide"](#)

Rako thanks you for having purchased a Rako product and hopes that you are pleased with your system. Should for any reason you need to contact us please contact us via our website www.rakocontrols.com or by phoning our customer help line on 01634 226666.



[Appendix: RAK-LINK diagnostics](#)

Requires ISSUE B circuit board and firmware version 0.4.6

RAK-LINK Blue LED Status			
Number	Colour	Indicates	Uses/example
1	Blue	Device activity	<ul style="list-style-type: none"> • Device in setup • Network looping poll
2	Blue	Power/ CAN bus activity	<ul style="list-style-type: none"> • Solid Power detected • Flashing CAN Bus Transmitting or receiving
3	Red	CAN Diagnostics	<ul style="list-style-type: none"> • CAN warning • CAN error

Red LED Status	Troubleshooting (Potential causes)
Warning: RED LED Fast flash	Continuously checked
Cause: Incorrect voltages measured on the RAK-LINK data lines. The system may still function.	<ul style="list-style-type: none"> • One or more data line(s) have been shorted to a power line. • RAK-LINK put into setup mode with no network attached. • The network is very busy (LED 2 will also be flashing fast).
Warning: RED LED Slow flash	Continuously checked
Cause: Power supply detected to be below 12V	<ul style="list-style-type: none"> • Power Supply failing. • Power is supplied from another source.
Error: RED LED solid	Checked on power-up and attempted transmission
Cause: CAN Transmission failure. The RAK-LINK has repeatedly failed to transmit a message.	<ul style="list-style-type: none"> • RAK-LINK put into polling mode with no network attached or CAN bus shorted together.

When the suspected fault has been resolved a power cycle is required to refresh the diagnostic LED.

NB

Caution should be exercised while using this table for diagnostic purposes. The suggested possible cause is the most likely of many possible outcomes but is not a guaranteed solution.