

Warmup[®]

The world's **best-selling** floor heating brand™

Installation Manual:

Underfloor Heating Inscribed Cable System

TECHNICAL HELPLINE

0845 345 2288



IMPORTANT

Read this manual before attempting to install your inscribed heater. Incorrect installation could damage the heater and will invalidate your warranty.



Contents

- 3 Do's and don'ts
- 4 Heater information & testing
- 5 Technical information
- 6 Electrical provision for the heater(s)
- 7 Subfloor Information
- 8 Suitable screeds & cable spacing information
- 9 Installation
- 12 Warranty
- 16 Sizing guide table

Your Warmup® Inscreed Heater has been designed so that installation is quick and straight forward, but as with all electrical systems, certain procedures must be strictly followed. Please check the sizing guide at the back of this manual to ensure that you have the correct heater(s) for the area you wish to heat.

Warmup plc, the manufacturer of the Warmup® Inscreed Heating System, accepts no liability, expressed or implied, for any loss or consequential damage suffered as a result of installations which in any way contravene the instructions that follow.

If these instructions are followed you should have no problems. However, if you do require help at any stage, please call our FREE helpline: **Warmup Technical Helpline 0845 345 2288**. You can also find a copy of this manual, wiring instructions, a list of frequently asked questions and more helpful information on our website: **www.warmup.co.uk**

Do's and don'ts

DO

- ✓ Carefully read this installation manual before commencing installation
- ✓ Keep the heating element at least 50mm apart at all times
- ✓ Ensure that all of the heating element, including the cold lead joint and end joint are laid within a minimum of 50mm screed.
- ✓ Space the heating element evenly across the floor to ensure even heat distribution
- ✓ Test the heating element before, during and after installation
- ✓ Ensure that the control card at the back of the manual is completed and fixed at the main consumer unit along with any plans and electrical test records. As per the current BS7671 wiring regulations
- ✓ Ensure that a heat loss calculation has been carried out and heating requirements have been met if you are using the heating system as a primary source of heating
- ✓ Ensure that all mains electrical connections must be undertaken by a Part "P" certified electrician. All work must conform to current IEE Wiring Regulations.
- ✓ Ensure that the heating element is protected by a 30mA RCD
- ✓ Ensure the heating element is separated from other heat sources such as luminaries and chimneys
- ✓ Install the floor sensor centrally between two adjacent runs of heating element
- ✓ Allow sufficient drying time of the floor/slab after installation. Minimum of 1mm per day drying time.

DON'T

- ✗ Cut, shorten or alter the length of the heating element in any circumstances
- ✗ Cross or overlap the heating element at any point
- ✗ Install the heating element up stairways or walls
- ✗ Install the heating element onto a new concrete floor for at least 30 days to allow the concrete to dry
- ✗ Tape over the manufactured joints to hold them in place
- ✗ Attempt a DIY repair if you damaged the heating element. Contact Warmup immediately
- ✗ Overlap the floor sensor cable over or under the heating element
- ✗ Turn on the heating element to help dry out the screed
- ✗ Turn on the heating element until the screed on top has been given sufficient time to dry out
- ✗ Install the floor sensor close to other heat sources such as hot water pipes
- ✗ Bend the heating element under 60mm radius
- ✗ Do Not wire the heaters in series, the heaters must be connected in parallel.

Heater Information

The heaters consist of a fixed length of heating wire terminated at one end by a sealed joint and the other end by a 2.5m power supply cable (cold tail).

The cable is a twin conductor surrounded by an earth shield for electrical protection. The wire has been designed to be placed within a cementitious screed of at least 50mm in thickness. The product is designed for a 230 Volt electrical supply and produces between 100 to 200 Watts per square meter of heating, depending on the spacing of the wire (see sizing guide for details at rear of the manual).

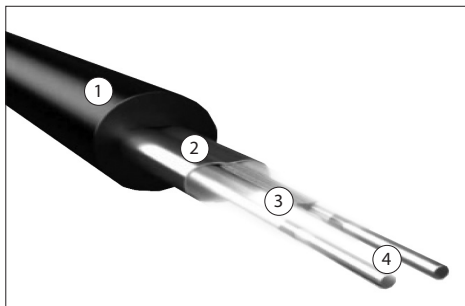

- ① Sheath
- ② Metal Shielding
- ③ Insulation
- ④ Cores

Testing the heater

The heaters must be tested before, during and after tiling. We recommend the use of a digital multi-meter set to a range of 0-2 K ohms for testing. The resistance (ohms) of each heater should be measured. You should carry out the following tests and should expect the results detailed below:

- Live to neutral should show the Ohms value listed in the table on page 5.
A +/- 5% Ohm reading tolerance is allowed under manufacturing guidelines. Record the readings on the control card at the back of the manual.
- Live to earth and neutral to earth should show infinity.

NOTE: Due to the high resistance of the heating element, it may not be possible to get a continuity reading from the heater and as such, continuity testers are not recommended. When checking resistance, make sure your hands do not touch the meter's probes as the measurement will include your internal body resistance and render the measurement inaccurate.

If you do not get the expected results or at any time you believe there may be a problem, please contact Warmup's Technical Team on 0845 345 2288 for guidance.

Floor Sensor

Ensure that the floor sensor is tested before the final floor finish has been laid. When testing the floor sensor ensure that the meter can read up to 20k ohms.

Technical Information

Heaters	Heater length	Wattage	Voltage	Amps	(-5%)	Ohms	(+5%)
WIS180	9.0	180	230	0.8	279.2	293.89	308.58
WIS280	14.0	280	230	1.2	179.5	188.93	198.38
WIS390	19.5	390	230	1.7	128.9	135.64	142.42
WIS500	25.0	500	230	2.2	100.5	105.80	111.09
WIS650	32.5	650	230	2.8	77.3	81.38	85.45
WIS760	38.0	760	230	3.3	66.1	69.61	73.09
WIS1000	50.0	1000	230	4.3	50.3	52.90	55.55
WIS1200	60.0	1200	230	5.2	41.9	44.08	46.29
WIS1460	73.0	1460	230	6.3	34.4	36.23	38.04
WIS1550	77.5	1550	230	6.7	32.4	34.13	35.84
WIS1770	88.5	1770	230	7.7	28.4	29.89	31.38
WIS2070	103.5	2070	230	9.0	24.3	25.56	26.83
WIS2600	130.0	2600	230	11.3	19.3	20.35	21.36
WIS3140	157.0	3140	230	13.7	16.0	16.85	17.69
WIS3370	168.5	3370	230	14.7	14.9	15.70	16.48

As with all electrical projects which are subject to Part P Building Regulations, all electrical work should be carried out by a certified/qualified electrician. All work must conform to latest version of BS 7671 IEE Wiring Regulations.

Making electrical provision for the heater

As with all electrical projects governed by Part P regulations, all mains electrical connections must be undertaken by a certified electrician. All work must conform to current IEE Wiring Regulations. The Underfloor heating must be controlled via a floor sensor thermostat at all times.

Installing a Residual Current Device (RCD)

Warmup® Inscreeed Heaters must be wired via an 30mA RCD. You must install a dedicated RCD if one is not already present. You may wish to use a fused spur/RCD. No more than 4.8kW of heating may be connected to a single 30mA RCD.

NOTE: It is possible to run the heater from an existing circuit. Consult a certified electrician to determine whether or not the circuit can handle the load and if it is RCD protected.

Installing Electrical Boxes and Trunking

You will require a deep (35-40mm) back box for the thermostat. If you are installing more than two heaters, a junction box will be required. The wiring from the heater to the thermostat should be protected by conduit or plastic trunking.

Connecting the Thermostat

The thermostat must be connected to the mains electrical supply via a double pole isolator fused spur or RCD that has a contact separation in all poles providing full disconnection under over-voltage category III conditions. The thermostat should be installed within the room to be heated. In most bathroom installations the thermostat cannot be located within the bathroom itself must be located outside of Zone 2. In such cases the thermostat must be fitted to the outside of an internal wall of the bathroom, as close to the underfloor installation as possible.

Warmup thermostats are rated up to 16 amps. For larger installations exceeding 16 amps multiple thermostats or a suitable contactor will be required. For further advice contact Warmup on 0845 345 2288.

Once the electrical connections have been made and the system has been tested, the electrician must complete the control card at the back of this installation manual. As per BS7671 this information must be displayed at or near to the consumer unit

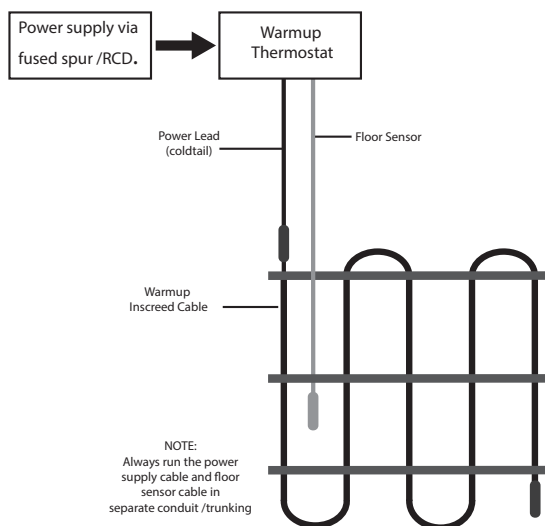

Subfloor Considerations

Option 1 - Wire laid directly on insulation. For use where the concrete base is thicker than 100mm or uninsulated.

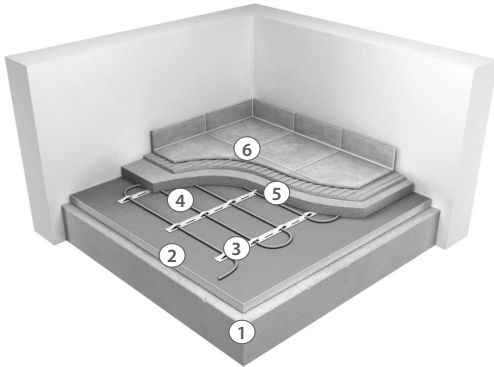

- ① Subfloor
- ② Insulation*
- ③ Fixing Strips
- ④ Inscreed Heater
- ⑤ Screed (min 50mm)
- ⑥ Final Floor Finish

* Insulation must be either foil faced or concrete faced and suitable for use with electric underfloor heating

**Option 2 - Wire Laid directly onto concrete pad
For use where the concrete base is less than 100mm thick and insulated.**

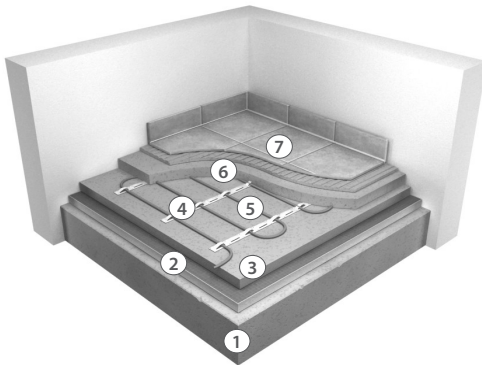

- ① Subfloor
- ② Insulation
- ③ Concrete Pad
- ④ Fixing Strips
- ⑤ Inscreed Heater
- ⑥ Screed (min 50mm)
- ⑦ Final Floor Finish

While it is acceptable to lay the heating element directly onto an insulated concrete base, insulation directly below the heater will improve the efficiency of the system. Ensure that the levels of insulation will meet your heating requirements.

The subfloor of the project should be suitable for screeding. The floor should be rigid, of a suitable material and free of debris and dust. Any holes in the floor should be sealed or filled with a suitable material. Any sharp objects or materials which may potentially damage the heating wire should be removed.

Note: The inscreeed cable should be covered with a minimum 65mm screed in order to comply with the Part L building regulations.

Suitable screeds

Sand & Cement (with added fibres)

Sand and cement screeds are a mixture of sand and cement generally in a 4 to 1 mixture ratio with water.

Fast Drying Screeds

This type of screeds have additives mixed along with the cement sand mixture to improve their drying time.

Anhydrite (Calcium Sulphite) Screeds

Anhydrite screeds is made from calcium sulphate, sand, water and other chemicals to form a liquid screed. Unlike sand and cement screeds (which are spread, compacted and levelled), the screed is poured onto the floor. Large areas can be covered much quicker with this screed type.

It is essential however, that the floor and edge insulation must be fully waterproofed by sealing all joints with a suitable sealing tape or silicone.

Important Information

The floor should be allowed to cure and dry naturally until full strength is reached as per British Standards and manufacturer's instructions. The full drying time of the floor will depend on the depth and products used.

Choosing the correct heater

Firstly you will need to calculate the total m² of floor area you have in the room to be heated. Then deduct any areas which will be unheated i.e. where any fixed units such as baths, shower trays, kitchen units etc. This will give you the total area to be heated.

How the cable spacing is calculated

To calculate the spacing between each run of heating element you simply multiply the total floor area to be heated by 1000 divided by the total length of heating element used. (See the back of the manual for the correct cable spacing for each system)

For Example

$$16.8\text{m}^2 * 1000 / 168.5\text{m} = 100\text{mm spacing}$$

How the wattage output per m² is calculated

To calculate the wattage output per m² you will have, divide the wattage listed for your cable/s by the m² free floor area that you have to heat.

For Example

$$3140\text{W} / 20.9\text{sqm} = 150\text{W}$$

Installation (using metal fixing strips)

Step 1

It is advised that a floor plan is drawn up to determine the placement of the thermostat, heating cable and the floor sensor. This diagram should be kept for future reference.

The subfloor should be solid, level, dust and debris free. The inscreed cable **MUST** always be laid on a cement or foil facing insulation board. Ensure that the entire subfloor is of the same construction in order to provide even performance.

NOTE: Always confirm with the manufacturer of the insulation or Warmup for suitability of the insulation.

The inscreed cable **MUST NOT** be installed on top of a soft insulation material, it must have a layer of self levelling compound to ensure an even spread of heat.

Alternatively you can lay the inscreed cable directly onto a well insulated concrete base, however additional insulation is recommended.

Step 2

When installing two or more heaters, begin by reading the sizing guide at the back of this booklet to ensure that you have the correct number and size of heaters for the area you wish to heat.

Next test the resistance of the heaters to ensure they are in line with the resistance readings at the back of this manual. A +/- 5% ohm reading tolerance is allowed under manufacturing guidelines. If the heater is not working call the technical helpline on 0845 345 2288.

Step 3

To secure the inscreed cable to the subfloor you will need metal fixing strips. The metal fixing strips should be laid out perpendicular to the heating element. These fixing strips must be secured to the insulation board or the concrete floor using fixing nails or an adhesive. It is important to ensure there is no movement of the fixings.

The fixing strips should be evenly spread across the floor at intervals of 0.75 meters. The fixing strips should be placed so as to leave a 100mm border all the way around the room as the heating cables should not touch walls, kickboards etc.

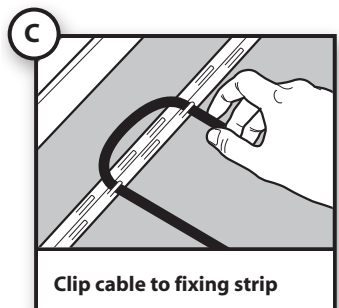
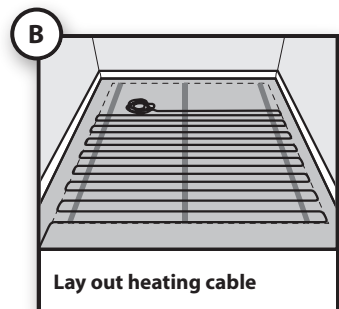
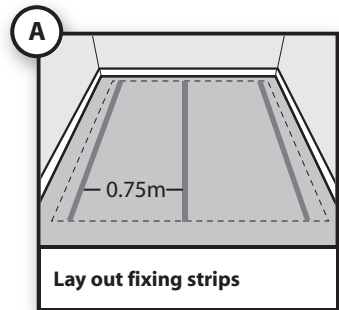

Installation (using metal fixing strips)

Step 4

The heating cable should then be laid up and down the room and clipped into the fixing strip. The cable spacing is determined by the product model (see sizing guide). The cables should be evenly spaced at all times to ensure an evenly heated floor (minimum spacing = 50mm). The cables should never cross or touch each other. Similarly the floor sensor should not cross or go over or under the heating cables. If you find that you have too much heating cable left over after the heater has been laid **DO NOT** shorten the heating element. Contact Warmup on 0845 345 2288.

All of the heating element including the coldtail joint and end termination joint must be laid within the area to be heated and embedded within the screed.

DO NOT cover these joints with tape to hold them in place.

Other fixing Methods

Tape

The Inscreed heating cable may also be fixed to the base using heavy-duty tape. It is important to ensure that there are no air pockets between the heating cable and the tape. When using this method ensure that the base is dry and clean. Do not tape over the cold lead joint or end termination joint as air pockets in the tape can cause the joints to overheat and fail.

Fixing to reinforcement mesh with cable ties

The Warmup Inscreed heating cables can also be secured directly to a reinforcement mesh using cable ties. Reinforcement mesh is often used to strengthen screed beds and help prevent them cracking. It consists of a grid made up of thick metal bars which the screed is then poured over the top of. When installing an inscreed cable it is possible to lash the cable to the reinforcement mesh with cable ties rather than having to use the fixing strips provided.

If this method is chosen it is important to ensure the cable spacing remains even.

Other fixing methods are available. Please contact Warmup on 0845 345 2288 if you require further information.

Step 5

Up to 2 heating cables can be wired into the back of the thermostat. More than 2 cables will require a junction box.

If total heating required exceeds the amperage rating of your thermostat (16A), your electrician can install a contactor to allow the heating system to operate using a single thermostat. Alternatively you will have to split the load using multiple thermostats.

Instructions for fitting the Warmup® Thermostat can be found inside the thermostat box.

Sensor Location

The Floor sensor supplied with the thermostat should be fitted as close to the final floor finish as possible. The sensor can be installed a number of ways:

- Placed directly in the top 10mm of screed covering the heating wire.
- Cemented into a channel cut out of the surface of the screed.
- Placed in a flexible conduit in the top 10mm of screed.

Installation

Remember to test the heater/s with a multi-meter again before you commence with the top layer of screed.

If you do not intend to screed over the heater straight away keep any traffic above the cable to a minimum. **DO NOT** cut tiles over the heated area or drop sharp objects or tiles onto the cables as this can crush or cut into them. Make sure to regularly check the resistance of the cable with a multi-meter during installation. Contact Warmup on 0845 345 2288 if you do not get a resistance reading or the resistance falls outside the +/- 5% tolerance.

Step 6

The cementitious screed should be carefully poured over the heating cables to an even depth of at least 50mm. **DO NOT** use the heating cables to 'dry out' the screed, as this could lead to the screed cracking. The screed must be allowed to dry completely before laying the floor covering.

Once the screed or levelling compound has fully dried the final floor covering can be laid.

Tiles

If a tiled floor is being laid, flexible tile adhesive and grout must be used with the underfloor heating.

Laminate/Wood

With laminate or engineered board floors it is essential that it is no more than 18mm thick to ensure that the heat can transfer through the covering. If you are using a layer of soft insulation beneath the flooring it must be compatible with installation on top of an underfloor heating system.

Carpet

For carpeted floors, hessian backed carpets must be used and the Tog rating of the carpet and underlay must not exceed 2.5 tog.



Terms and conditions apply
Model: Inscreeed heater manufactured by Warmup plc -

THE 10 YEAR GUARANTEE DOES NOT EXTEND TO THERMOSTATS WHICH ARE COVERED BY SEPARATE GUARANTEES. THIS GUARANTEE DOES NOT AFFECT YOUR STATUTORY RIGHTS.

The Warmup® Inscreeed Heater is guaranteed by Warmup plc ("Warmup") to be free from defects in materials and workmanship under normal use and maintenance, and is guaranteed to remain so subject to the limitations and conditions described below. The INSCREEED HEATER is guaranteed for 10yrs, except as provided below (and your attention is drawn to the exclusions listed at the end of this guarantee).

This 10yr guarantee applies:

1. only if the unit is registered with Warmup within 30 days after purchase. Registration can be completed by filling out the card accompanying this guarantee or online at www.warmup.co.uk. In the event of a claim, proof of purchase is required, so keep your invoice and receipt - such invoice and receipt should state the exact model that has been purchased; and
2. only if the heater has been earthed and protected by a Residual Current Device (RCD) at all times.

Thermostats are guaranteed for a period of 3 YEARS from the date of purchase, except as provided below. Neither guarantee continues if the floor covering over the heater(s) is damaged, lifted, replaced, repaired or covered with subsequent layers of flooring. The guarantee period begins on the date of purchase. Registration is confirmed only when a letter of confirmation is sent by Warmup plc.

During the period of the guarantee Warmup will arrange for the heater to be repaired or (at its discretion) have parts replaced free of charge. The cost of the repair or replacement is your only remedy under this guarantee which does not affect your statutory rights. Such cost does not extend to any cost other than direct cost of repair or replacement by Warmup and does not extend to costs of relaying, replacing or repairing any floor covering or floor.

If the heater fails due to damage caused during installation or tiling, this guarantee does not apply. It is therefore important to check that the heater is working (as specified in the installation manual) prior to tiling.

WARMUP PLC SHALL IN NO EVENT BE LIABLE FOR INCIDENTAL OR CONSEQUENTIAL DAMAGES, INCLUDING BUT NOT LIMITED TO EXTRA UTILITY EXPENSES OR DAMAGES TO PROPERTY.

WARMUP PLC is not responsible for:

1. Damage or repairs required as a consequence of faulty installation or application.
2. Damage as a result of floods, fires, winds, lightning, accidents, corrosive atmosphere or other conditions beyond the control of Warmup plc.
3. Use of components or accessories not compatible with this unit.
4. Products installed outside the United Kingdom.
5. Normal maintenance as described in the installation and operating manual, such as cleaning thermostat.
6. Parts not supplied or designated by Warmup.
7. Damage or repairs required as a result of any improper use, maintenance, operation or servicing.
8. Failure to start due to interruption and/or inadequate electrical service.
9. Any damage caused by frozen or broken water pipes in the event of equipment failure.
10. Changes in the appearance of the product that does not affect its performance.

Documentation of Ownership, Installation & Part P Electrical Connection

This form must be filled out completely, otherwise you may invalidate your warranty

Owner's Name

Owner's Address

.....

Post Code Telephone

Email

Installer's Name

Installer's Telephone Number

I hereby confirm that I have read & understand the contents of the installation manual & that the heater(s) has been installed as specified therein. I acknowledge that no claim can be brought against the manufacturer or its agents for any consequential loss or damage whatsoever. I confirm that the heater(s) was working prior to tiling.

Installer's Signature Date

Electrician's Name

Electrician's Address

.....

Electrician's Telephone Number

Electrician's Part P Certificate Number

Table of heaters installed:

Heater/Room	Model No.	Serial No.	Batch No.	RCD Rating	Resistance Reading
1					
2					
3					
4					
5					

Place this card in a visible spot close to the consumer unit.

Warmup

Heater Location _____

Total Wattage _____

CAUTION
Radiant Floor Heating Systems
Warming-Risk of electric shock
Electric-wiring and heating panels
contained below the floor. Do not
penetrate with nails, screws, or similar
devices. Do not restrict the thermal
emission of the heated floor.



Attention:

Do **not** cut or shorten the heating element.

Ensure that the entire heating elements including the joints are installed under the tiles in the installation.

The Heating element must be used in conjunction with a 30mA RCD.

Heater Model	Resistance Before	Resistance After	Insulation Resistance

_____ Date

_____ Signed

_____ Company stamp/name

This form must be completed as part of the Warmup Guarantee. Ensure that the values are as per the instruction manual.

This card must be situated close to the consumer unit in a visible place.

Note: Draw a Plan showing the layout of the heater.

Notes

Note: Draw a plan showing the layout and location of the inscreed heater (s)

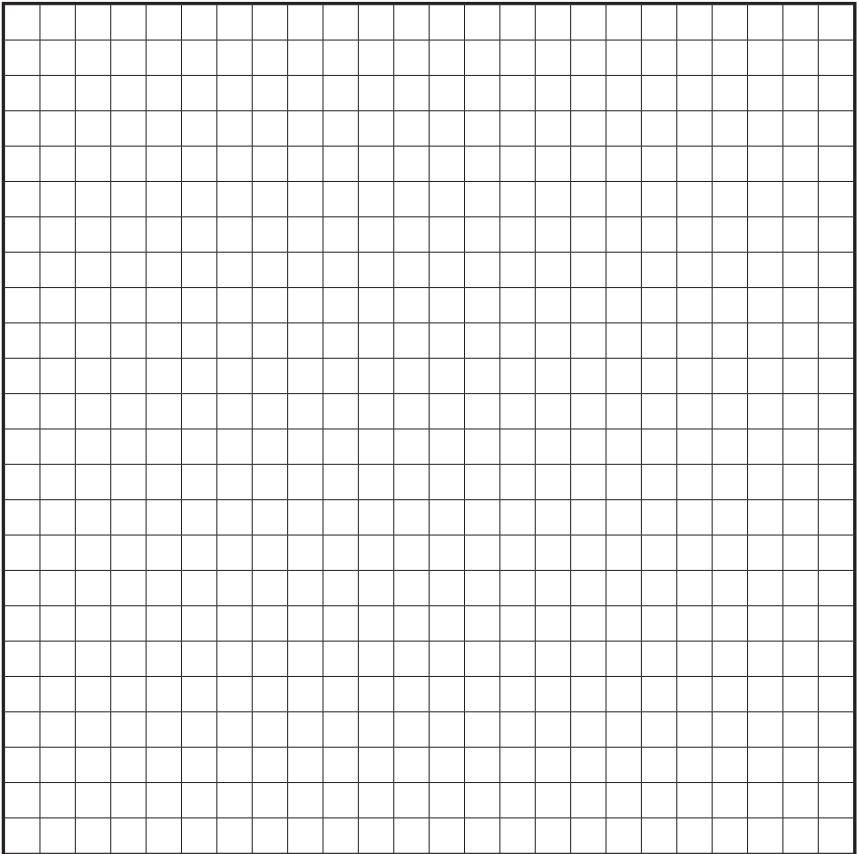

Heater Sizing & Wire Spacing Guide

Heater Model	Heater Length	Overall Resistance	Voltage	Total Wattage	Total Amperage	100W/m ²	150W/m ²	200W/m ²
						Spacing 200mm	Spacing 133mm	Spacing 100mm
						Area covered (sqm)	Area covered (sqm)	Area covered (sqm)
WIS180	9.0	293.9	230	180.0	0.78	1.8	1.2	0.9
WIS280	14.0	188.9	230	280.0	1.22	2.8	1.9	1.4
WIS390	19.5	135.6	230	390.0	1.70	3.9	2.6	2.0
WIS500	25.0	105.8	230	500.0	2.17	5.0	3.3	2.5
WIS650	32.5	81.4	230	650.0	2.83	6.5	4.3	3.3
WIS760	38.0	69.6	230	760.0	3.30	7.6	5.1	3.8
WIS1000	50.0	52.9	230	1000.0	4.35	10.0	6.7	5.0
WIS1200	60.0	44.1	230	1200.0	5.22	12.0	8.0	6.0
WIS1460	73.0	36.2	230	1460.0	6.35	14.6	9.7	7.3
WIS1550	77.5	34.1	230	1550.0	6.74	15.5	10.3	7.8
WIS1770	88.5	29.9	230	1770.0	7.70	17.7	11.8	8.9
WIS2070	103.5	25.6	230	2070.0	9.00	20.7	13.8	10.4
WIS2600	130.0	20.3	230	2600.0	11.30	26.0	17.3	13.0
WIS3140	157.0	16.8	230	3140.0	13.65	31.4	20.9	15.7
WIS3370	168.5	15.7	230	3370.0	14.65	33.7	22.5	16.9

NOTE: All spacings have been based on square areas for calculation purposes. Therefore actual spacing will vary according to the shape of the area to be heated. All spacings should be measured from the centre of the wire.