

# TONA

5189601118



User manual  
Bedienungsanleitung  
Mode d'emploi  
Handleiding  
Manuale  
Manual del usuario  
Használati utasítás  
Instrukcja obsługi



# LUTEC

**Incl.**

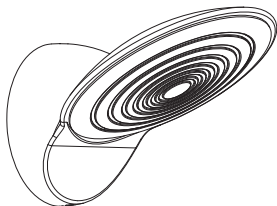

x 2



x 2

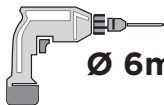

**Ø 6mm**

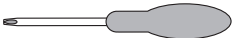

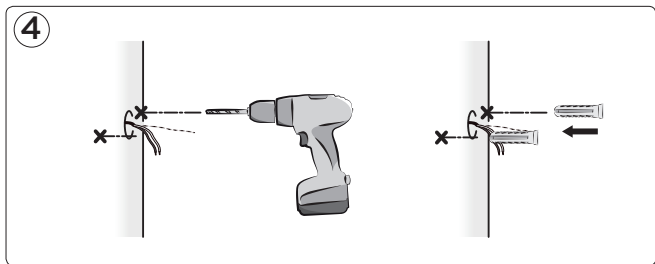
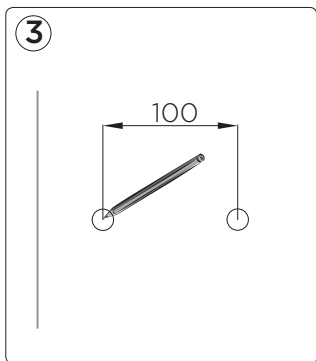
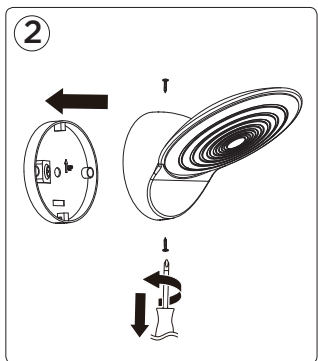
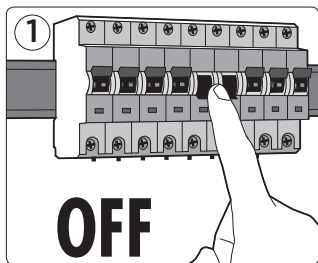

5

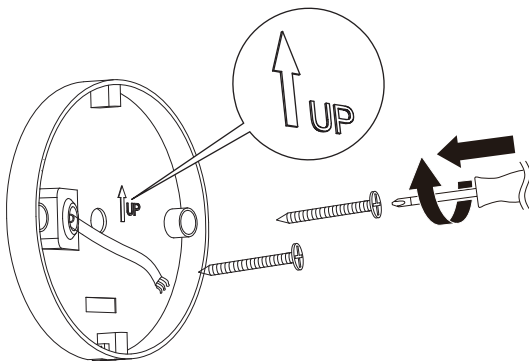

6

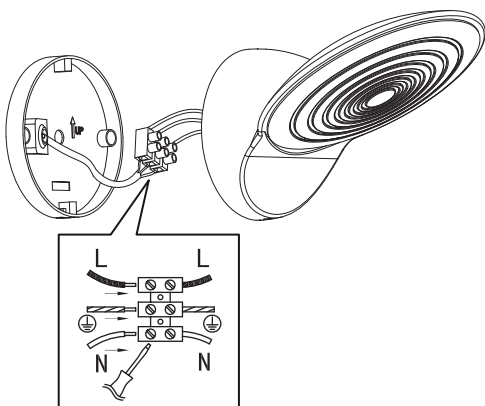

7

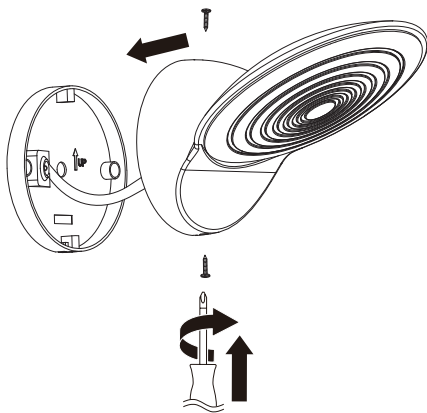



## **LUTEC Europe NV**

Herentalsebaan 425  
B-2160 Wommelgem - Belgium  
+32 3 284 51 62  
info@luteceurope.com  
www.luteceurope.com



[www.luteceurope.com/services/global-network](http://www.luteceurope.com/services/global-network)