



Wireless
data sheet
RLED75CV1

WIRELESS 75W CONSTANT VOLTAGE LED DIMMER.



WHAT IS IT ?

A compact single channel 75W constant voltage LED dimmer with in-built RF receiver and Rako processor for control of single channel constant voltage LED fittings.

Controlled from any Rako Rakom device, e.g. RCP/RCM wall plates or Bridge interface units.

The RLED75CV1 is a wireless 75w constant voltage dimming LED driver, suitable for ceiling or cupboard mounting.



IN CONTROL

Designed for use with single channel constant voltage LED fittings and single channel LED tape light.

Maximum wattage of 75w for 12V d.c. fittings or 150w for 24V d.c. fittings. Requires a suitable external d.c. power supply (normally the power supply that would be supplied with the fitting for a non-dimming application).

Programmed using either an RCM/RCP RF wallplate or the RASOFT PC software suite, the unit stores the house, room and channel address plus 16 preset scene levels in non volatile memory.

The RLED75CV1 dimmer can be controlled from any Rako transmitter such as RCM/RCP wallplates, RAH hand helds and Bridge modules and forms the foundation of any Rako scene-set system.

For more information on dimming LEDs refer to Rako's application sheet 'Controlling LED Lighting With Rako Dimmers and Modules'.



Wireless

data sheet

RLED75CV1

WIRELESS 75W CONSTANT VOLTAGE LED DIMMER.



technical data

dimensions	138x46x40mm
input supply	12 or 24vDC
weight	125g
housing	UL V0 ABS
climate range	Temperature +2C to +40C Humidity +5% to 95% non condensing
connections	2 way screw terminals for 12-24v d.c. supply. 4 way screw terminals for load connections.
protection	Reverse polarity input protection. Output current limit protection.
load types	Single channel constant voltage LED fittings and tapelight.
minimum load	1w
maximum load	75w @ 12v d.c. 150w @ 24v d.c.
terminal sizes	4mm ²
standards	Emissions - EN61000-6-3 : 2001 Immunity - EN61000-6-1 : 2001
communication	Rakom coded fm radio, 433.9MHz
memory	Flash memory non volatile

mechanical data

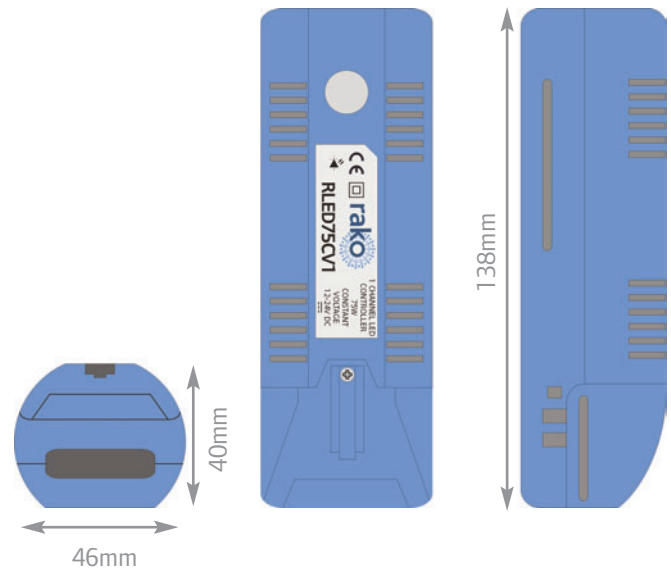

wiring schematic

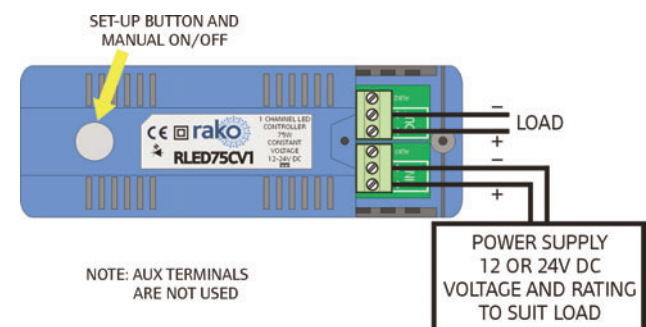

telephone +44 (0) 1634 226666 fax +44 (0) 1634 226667 www.rakocontrols.com

WE RESERVE THE RIGHT TO CHANGE THE SPECIFICATION AND DATA HEREWITH WITHOUT NOTICE.

© 2014 RAKO CONTROLS LIMITED