

TIMEGUARD®

180° Tamper-proof
Wall Mounted PIR

Model: MLTP180BK – Black

Model: MLTP180WH – White



Installation & Operating Instructions

1. General Information

These instructions should be read carefully and retained for further reference and maintenance.

2. Safety

- Before installation or maintenance, ensure the mains supply to the PIR sensor is switched off and the circuit supply fuses are removed or the circuit breaker turned off.
- It is recommended that a qualified electrician is consulted or used for the installation of this PIR sensor and install in accordance with the current IEE wiring and Building Regulations.
- Check that the total load on the circuit including when this PIR sensor is fitted does not exceed the rating of the circuit cable, fuse or circuit breaker.

3. Technical Specifications

- 230V AC 50 Hz
- This PIR sensor is of Class II Construction and must not be earthed
- Detection Range: Up to 12m at a 2.5m mounting height
- Detection Angle: 180°
- Maximum Switching Load: 2300W Halogen Lighting
500W Fluorescent and LED Lighting
- Time ON Adjustment: 2 seconds to 30 minutes
- Warm Up Time: 30 seconds
- Lux Adjustment: 2 to 1000 lux
- Operating Temperature: -25°C to +45°C
- Manual Override: Double pulse within 2 seconds,
to enter 6 hours ON time (night time only).
- Back Box Mounting Centres: 60mm
- IP55 Rated suitable for restricted external applications
- CE Compliant
- Dimensions (H x W x D): 81.8 x 81.8 x 67.1mm

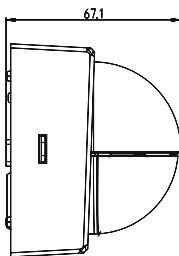
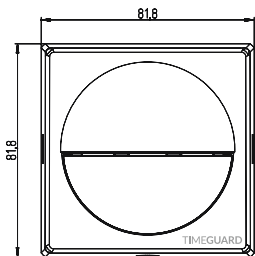

4. Selecting a Location

- Careful positioning of the sensor will be required to ensure optimum performance. The mounting height for the sensor should be 2.5m. See diagram A.
- The sensor is more sensitive to movement ACROSS its field of vision than to movement directly TOWARDS. Therefore position the unit so that the sensor looks ACROSS the likely approach path.
- Avoid positioning the sensor where there are any sources of heat in the detection (extractor fans, tumble dryer exhausts etc.). See diagram B.
- Reflective surfaces (i.e. pools of water or white-painted walls) may cause false activation under extreme conditions.

2

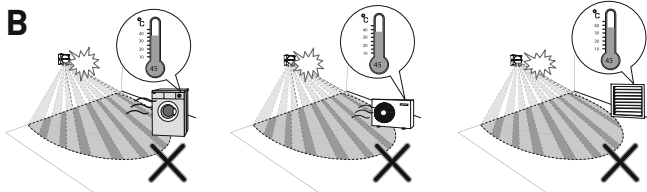
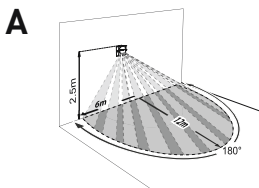

5. Installation

- 5.1 Ensure the mains supply is switched OFF and the circuit supply fuses are removed or the circuit breaker turned OFF (See image 1).

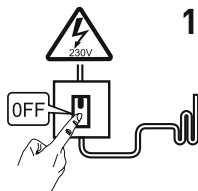

- 5.2 An isolating switch should be installed to enable the power to be switched ON and OFF for maintenance purposes and to activate the manual/auto override function.
- 5.3 Use a 2.5mm Allen key to unlock the captive latch located on the bottom of the sensor, by turning it anti-clockwise (quarter turn) so the dot indicator aligns with the 'Unlock' symbol, then pull downwards (See image 2, a).
Note: the captive latch cannot be removed.
Use a flat head screwdriver to press in the lugs on each side of the PIR sensor to unfasten the front cover (See image 2, b).

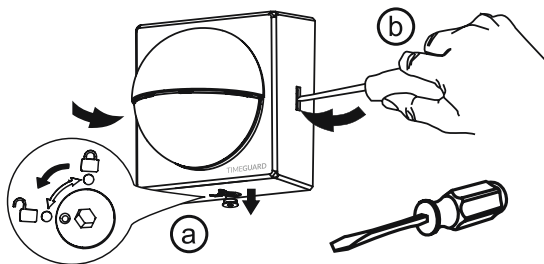

- 5.4 With both lugs pressed in, remove the front cover by pulling it away from the PIR sensor (See image 3).

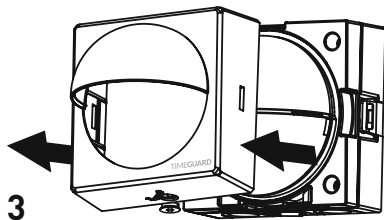

- 5.5 Undo the 4 fixing screws and remove the PIR sensor from the back box (See image 4).

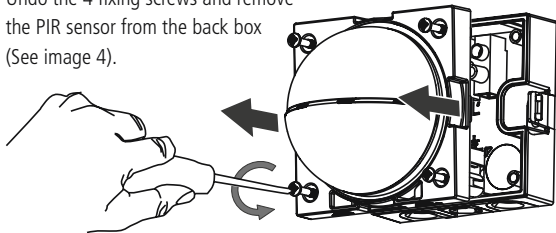

- 5.6 Mark the position of the mounting holes on the wall using the back box as a template (See image 5). Drill the holes ensuring not to infringe with any gas/water pipes or electrical cables that may be hidden below the surface. Insert the rawl plugs into the holes.

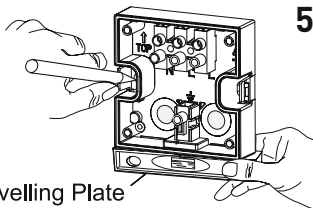

Levelling Plate

- 5.7 Pass the 230V 50Hz supply and load cables through the cable entry points on the back box, ensuring the grommets are used to maintain the IP rating of the PIR sensor (See image 6).

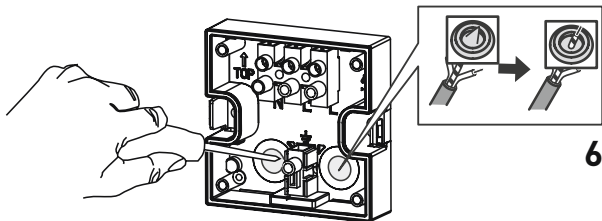

- 5.8 Fix the back box to the wall using the 2x mounting screws, making sure it is the correct way up. Take care not to over-tighten the screws to prevent damage to the back box. If using a power screwdriver, use the lowest torque setting (See image 7).

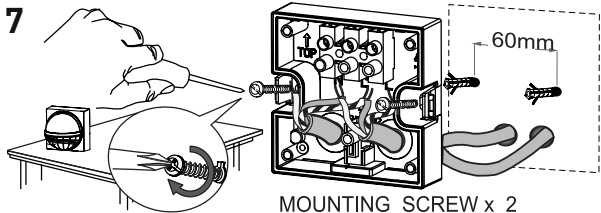

- 5.9 Terminate the 230V 50Hz mains supply and load cables into the terminal block (as per image 8) ensuring correct polarity is observed and that all bare conductors are sleeved (See section 6. Connection Diagram – for wiring details).

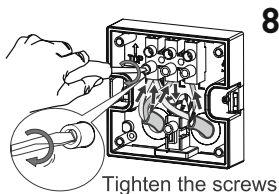

- 5.10 Position the PIR sensor over the back box, making sure the adjustments are located on the bottom, and secure using the 4x fixing screws previously removed in step 5.5. (See image 9).

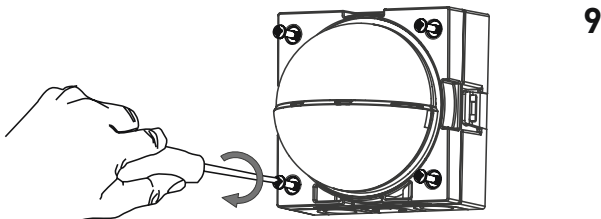

6. Connection Diagram

- Connect the cables to the terminal block as follows;

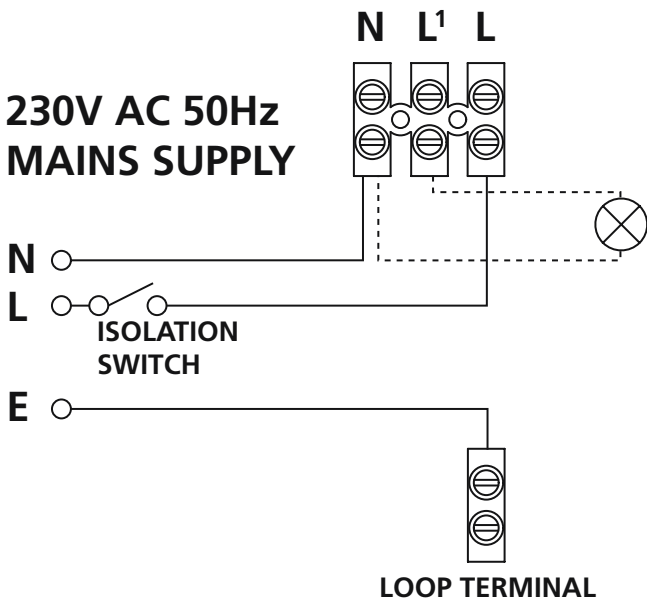

230V 50Hz Mains Supply

Live Supply (Brown or Red) to

L

Neutral Supply (Blue or Black) to

N

A 'Loop Terminal' is provided should a 3 core cable be used.

Load

Switch Live (Brown or Red) to

L¹

Neutral Load (Blue or Black) to

N

7. Setting Up

Walk Test Procedure (Test Mode)

- Make sure the PIR sensor is set to Test Mode i.e. the TIME ON Adjustment to the minimum (fully anti-clockwise), and the Lux Level set the Sun symbol (fully clockwise).
- Turn the power to the unit ON. The lamp will immediately illuminate as the unit goes through its 'warm-up' period. After approximately 30 seconds the lamp will extinguish. This indicates the unit is wired correctly and the unit is in Test Mode.
- Try to remain outside the detection area during the warm-up period.
- The unit will now operate during daytime as well as at night, illuminating the lamp for approx. 2 seconds each time. This allows testing to be carried out to establish whether the sensor is covering the required area.
- Walk across the location the sensor is fitted, to establish the detection zone.
- The sensor will detect you approximately up to 12 metres forward at mounting height of 2.5m.
- As you cross a detection 'zone' the lamp will illuminate. Now stand still until the lamp extinguishes (this should take approx. 2 seconds).
- Start moving again after 5 seconds. Each time you cross the detection 'zone' the lamp will illuminate.
- Repeat the above, walking at various distances and angles to the unit. This will help you to confirm the detection pattern (See image 10).

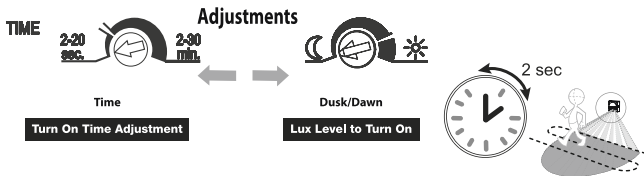
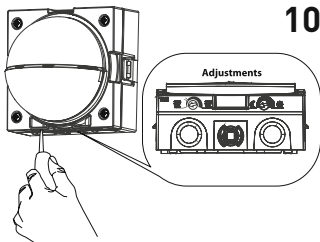

Setting Up for Automatic Operation (Auto Mode)

- When walk tests are complete, the unit can be adjusted for automatic operation.
- The TIME ON adjustment controls how long the unit remains illuminated following activation and after all motion ceases.
- Use a thin flat blade screwdriver to make adjustments.
- This can be set between 2 seconds to a maximum of 30 minutes.
- Set the control to the desired setting between these limits.
- The LUX Level adjustment determines the level of darkness required for the unit to start operating. The setting is best achieved by the procedure below;
 - 1 Set the LUX Level adjustment knob fully clockwise (Sun symbol).
 2. When the ambient light level reaches the level of darkness at which you wish the lamp to become operative (i.e. at dusk) SLOWLY rotate the control in an anti-clockwise direction until a point is reached where the lamp illuminates.
 - 3 Leave the control set at this point.
- At this position the unit should become operative at approximately the same level of darkness each evening.
- Observe the operation of the unit. If the unit is starting to operate too early (i.e. when it is quite light) adjust the control slightly anti-clockwise. If the unit starts to operate too late (i.e. when it is very dark). Adjust the control slightly clockwise.
- Continue to adjust until the unit operates as desired.
- Reposition the front cover over the PIR sensor (See image 11).

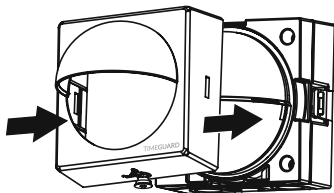

- Make sure the front cover clicks into place. Lock the captive latch located on the bottom of the sensor using a 2.5mm Allen key, by pushing up fully and then turning clockwise (quarter turn), so the dot indicator aligns with the 'Locked' symbol (See image 12).

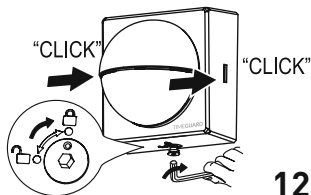

12

8. Manual Override

- The light can be switched ON for longer time periods by use of the Manual Override Mode. This can be activated at night time (only) by using the internal wall switch or circuit breaker. Switch the internal wall switch twice (OFF/ON, OFF/ON) within 2 seconds.
- The unit will now illuminate continuously for 6 hours, or until it is switched back into Auto Mode.
- To return to Auto Mode, switch the internal wall switch OFF and then back ON again within 2 seconds.
- The unit will return to its Auto Mode and will operate normally as set up.

9. Lens Mask

- There is 1x lens mask included in the accessory pack.
- The purpose of the lens mask is to mask out areas not desired for detection. You can restrict left or right detection, or reduce detection zone to cover a smaller area.
- Use some pliers or a suitable tool to cut out the mask segment, exposing the required area of detection.
- Position the lens mask over the sensor and click into place.

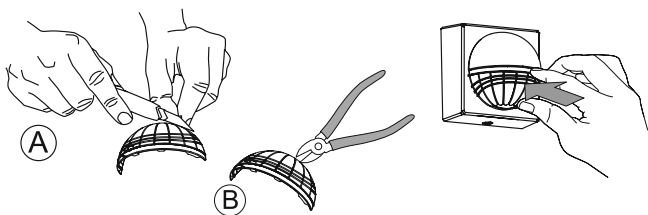

10

3 Year Guarantee

In the unlikely event of this product becoming faulty due to defective material or manufacture within 3 years of the date of purchase, please return it to your supplier in the first year with proof of purchase and it will be replaced free of charge. For years 2 and 3 or any difficulty in the first year, telephone the helpline on 020 8450 0515.

Note: A proof of purchase is required in all cases. For all eligible replacements (where agreed by Timeguard) the customer is responsible for all shipping/postage charges outside of the UK. All shipping costs are to be paid in advance before a replacement is sent.

If you experience problems, do not immediately return the unit to the store. Telephone the Timeguard Customer Helpline;

HELPLINE

020 8450 0515

or email helpline@timeguard.com

Qualified Customer Support Co-ordinators will be on-line to assist in resolving your query.



A **theben** Group Company

For a product brochure please contact:

Timeguard Limited.

Victory Park, 400 Edgware Road,

London NW2 6ND

Sales Office: 020 8452 1112

or email csc@timeguard.com

www.timeguard.com