

## Wagobox Light

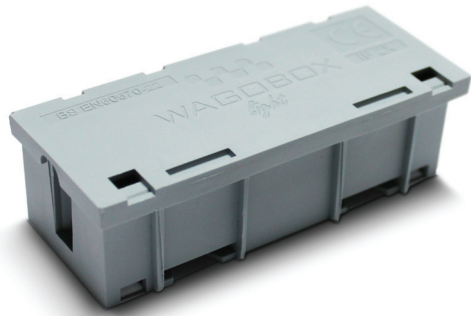

A multipurpose electrical junction enclosure that has been designed for use with the Wago 224 series terminal blocks. The Wagobox Light is easy to use and quick to fit.

### Fast

- Installing a Wagobox light can take as little as 25% of the time it takes to install a screw terminal style junction box.
- Cables are cut to size and connected outside the box.
- No awkward connections in a small space.

### Easy to use

- No screws or fiddly clamp bars.
- Cables slot into position and are secured in seconds.
- Uses simple to fit Wago 224 terminals.

### Compact

- Dimensions: 39mm x 29mm x 95mm.
- Supports up to 3 cables.
- Fits through a 49mm diameter spot light hole.

### Configurable

- The integrated cable clamp can secure flex and 6242Y and 6243Y twin and earth cables..
- Robust cable grippers that can be configured in seconds to grip cables up to 8.00mm in diameter.
- Use with Wago 224-101 and 224-112 terminal blocks to suit the job.

### Professional

- Complies with BSEN60670-22.
- Meets all the requirements of the 17th Edition of BS7671

## Wago Terminals

**WAGO**® Pushwire to Cage Clamp Connectors



### 224-101

#### Pushwire to Cage Clamp

#### Conductor sizes:

1.0mm<sup>2</sup> - 2.5mm<sup>2</sup> Solid Core  
0.5mm<sup>2</sup> - 2.5mm<sup>2</sup> Stranded Core

**Current rating:** 24A

**Voltage rating:** 400V/4KV

### 224-112

#### 2 x Pushwire to Cage Clamp

#### Conductor sizes:

1.0mm<sup>2</sup> - 2.5mm<sup>2</sup> Solid Core  
0.5mm<sup>2</sup> - 2.5mm<sup>2</sup> Stranded Core

**Current rating:** 24A

**Voltage rating:** 400V/4KV

### 224-201

#### Cage Clamp to Cage Clamp

#### Conductor sizes:

0.5mm<sup>2</sup> - 2.5mm<sup>2</sup> Solid Core  
0.5mm<sup>2</sup> - 2.5mm<sup>2</sup> Stranded Core

**Current rating:** 24A

**Voltage rating:** 400V/4KV

Have you tried  
the original Wagobox?



T: +44 (0) 1788 568008 F: +44 (0) 1788 568050  
W: [www.wago.ltd.uk](http://www.wago.ltd.uk) E: [info@wago.ltd.uk](mailto:info@wago.ltd.uk)

# Wagobox Light a junction box innovation

Quick, easy to fit, compact and configurable

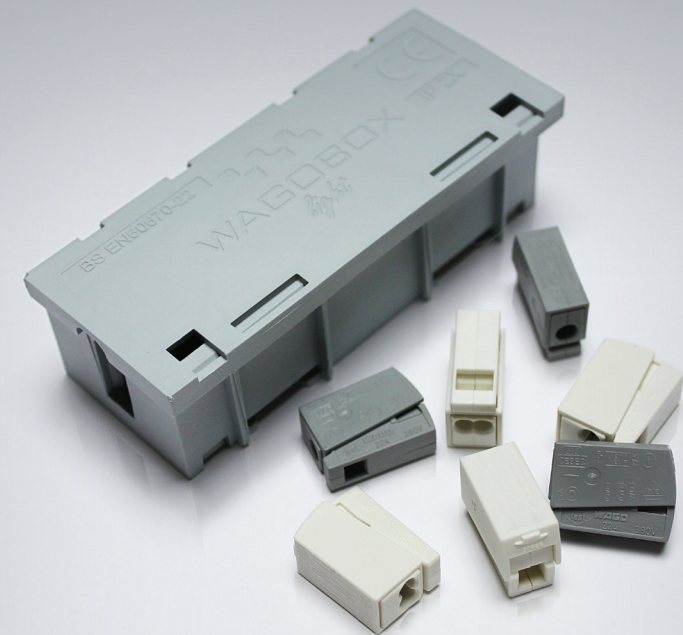

# Installation Instructions

The Wagobox-Light enclosure is designed for use with the 224 series of terminal blocks. The Wagobox is rated up to 400V and can support conductor sizes from 0.5mm to 2.5mm. The maximum number of supported individual conductor connections is twelve when using four 224-112 connectors.

*If you are in anyway unsure about any of the following steps or how to connect the circuit, then consult a qualified electrician.*

## Incredibly Simple...

The Wagobox is easy to use and fast to fit, just follow the steps below and see how the Wagobox will revolutionise the way you work.

- 1 Strip back the outer protective sheath** of the cables 35mm.



- 2 Select the appropriate 224 terminals for the circuit to be connected.** Strip the insulation to the recommended length.

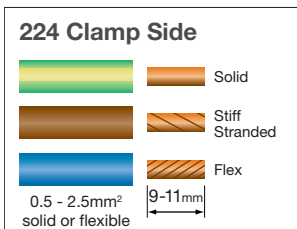
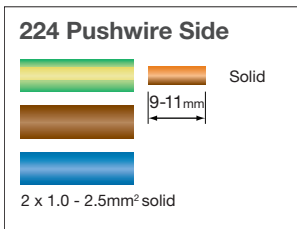

Wagobox-Light from  
  
[www.connexbox.com](http://www.connexbox.com)

- 3 Connect the cables together to make the circuit**

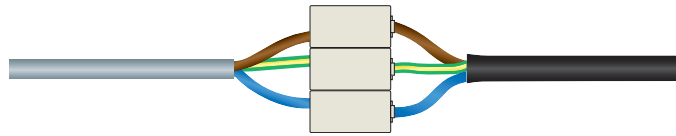

- 4 Configure the cable clamp** with the black plastic cable gripper

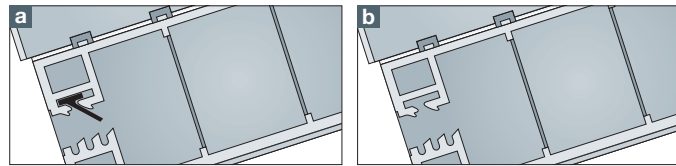

- a The black plastic gripper should be left in place** for cables with an overall diameter less than 6mm. Typically this will be 1.0mm<sup>2</sup>, 1.5mm<sup>2</sup> and 2.5mm<sup>2</sup> (6242Y) twin and earth and small flex.
- b For larger cables** with an overall diameter of approximately 7 to 8mm the black plastic gripper can be removed as the cables will be gripped without it.

- 5 Adjusting the gripper to make inserting cables easier.** If the diameter of the cable is approximately 5mm the gripper can be adjusted to make inserting the cable easier. Use a pair of narrow nosed pliers to squeeze the top of the gripper increasing the gap between the top edge of the gripper and the teeth of the cable clamp.

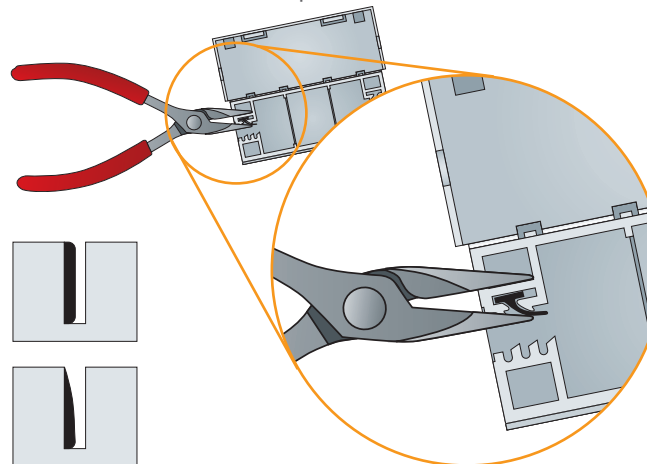

- 6 Arrange the cables and connectors** over the Wagobox ensuring the outer sheath of the cables protrudes past the grippers into the inside of the Wagobox.

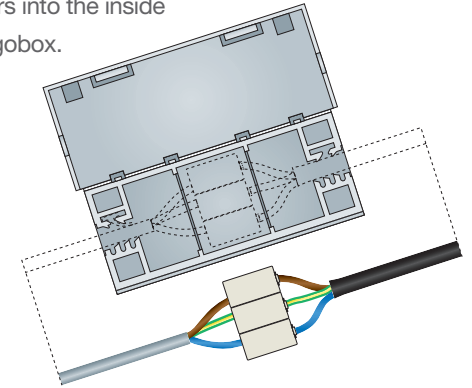

- 7 Push the cables down into the clamps** as far as they will go. **Close the lid and snap shut.**

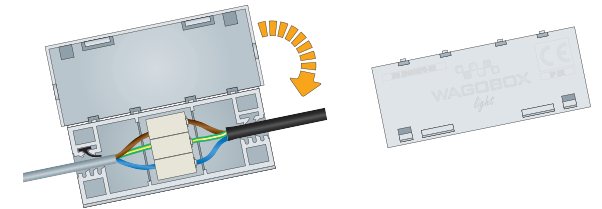

- 8 If required the Wagobox can be fitted to a surface** using the Wagobox **mounting button** feature. The base of the Wagobox has **two sliding slots**, either one or both can be used. Simply fix the mounting button to the required position and slide the Wagobox into place. The lid of the Wagobox can be secured or labelled with a **tie wrap** if necessary.

