



WAGOBX Capsule

Parts

Main Parts List

1. Lid: available in various colours
2. 81mm O-ring seal
3. 77mm O-ring seal
4. Capsule body: available in various colours including clear
5. Lid catch

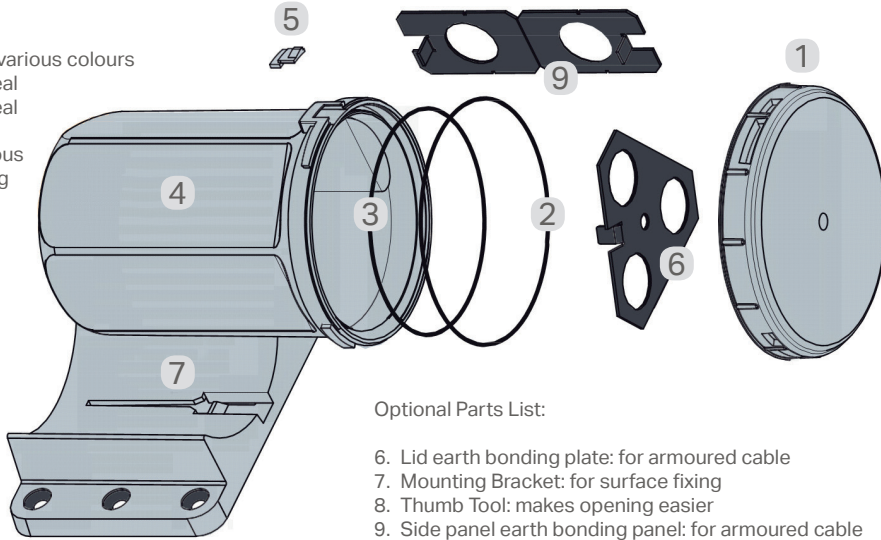

Optional Parts List:

6. Lid earth bonding plate: for armoured cable
7. Mounting Bracket: for surface fixing
8. Thumb Tool: makes opening easier
9. Side panel earth bonding panel: for armoured cable

Have you tried the WAGOBX-Light?



- A multi-purpose enclosure.
- Designed for use with the WAGO 224, 260 & 294 Series terminal blocks.
- Compact size and quick grip cable clamps make an excellent solution for downlighter applications.
- BS EN 60670-22 compliant, it meets all of the requirements of the 17th edition of BS7671.

Have you tried the WAGOBX?

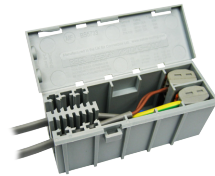

- A multi-purpose enclosure.
- Designed for use with the Wago 773 and 222 Series connectors.
- Compact size and quick grip cable clamps make an excellent solution for power and lighting applications.
- BS EN 5733-MF for maintenance-free applications.

Where

The WAGOBX-Capsule can be installed inside, outside or even directly buried into soil. The WAGOBX-Capsule is robust and manufactured from UV resistant materials allowing installation in locations that are sunny, wet, dusty or muddy. Care should be taken to avoid installation into locations that will result in severe forces being exerted directly onto the enclosure, such as directly under road surfaces and walk ways without sufficient coverage.

Why

Standard IP2X electrical enclosures do not protect the electrical terminals they contain from the surrounding environment. In locations where hazardous substances, such as water, are present terminals need to be protected to ensure that the safety of the electrical circuit is not compromised. Contamination of the electrical terminals can result in degradation of the electrical connection, arcing between terminals and tracking of dangerous voltages to the outside of the enclosure. The WAGOBX-Capsule protects the electrical terminals and can prevent the ingress of water and dust even when submerged, thus ensuring the circuit connections remain safe and secure.

IP Rated Glands

The WAGOBX-Capsule has been designed to be used with a range of different IP rated cable glands. The selection of the glands will depend on the degree of ingress protection required and the types of cable being connected.

	Compression Gland for non-armoured cables IP54 Ingress Protection: 5 = Dust protected 4 = Splashing of water
	Compression Gland for non-armoured cables IP68 Ingress Protection: 6 = No Ingress of dust 8 = Immersion in water
	Gland for armoured cables IP66 Ingress Protection (with sealing washer): 6 = No Ingress of dust 6 = Jets of water
	Encapsulated Compression Gland for armoured cables IP68 Ingress Protection: 6 = No Ingress of dust 8 = Immersion in water. Gland protected by corrosion guard so suitable for direct burial into soil.

WAGOBX Capsule IP68 Waterproof Enclosure

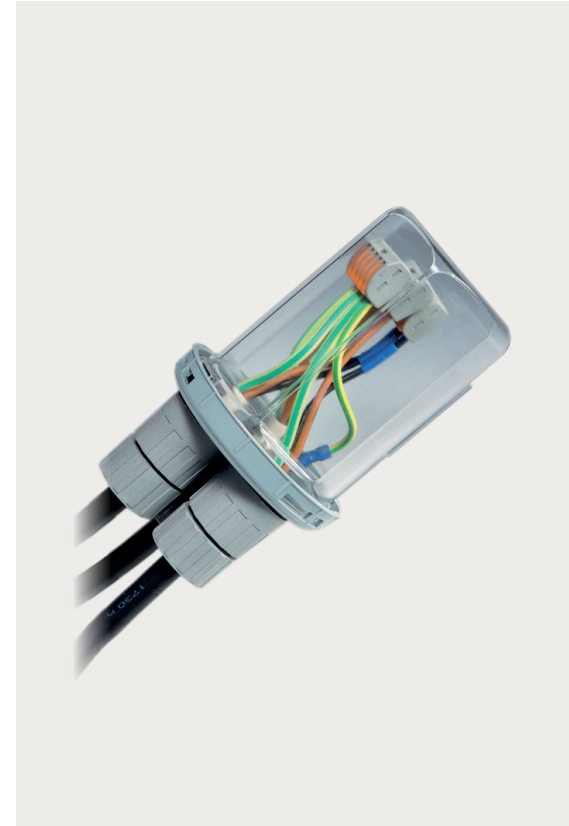

Installation Instructions

The WAGOBOX-Capsule is an IP68 enclosure, waterproof to a depth of 4 m when used with the appropriate cable glands.

Rated 400V / 4kV.

If you are in anyway unsure about any of the following steps or how to connect the circuit, consult a qualified electrician.

Incredibly Simple...

The WAGOBOX-Capsule is easy to use and fast to fit, just follow the steps below and discover how the WAGOBOX-Capsule can revolutionise the way you work.

1. Cut Gland Entry Holes

The size of the gland holes will depend on the glands to be fitted. The WAGOBOX-Capsule can be used with 16mm and 20mm glands although 20mm is the ideal gland size. Cut and deburr the entry holes to ensure the glands fit neatly to the capsule surface.

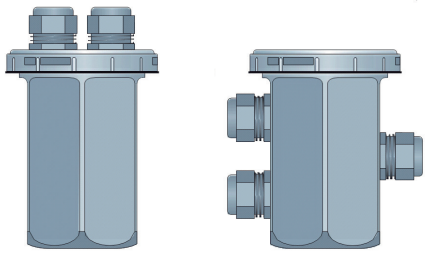

Cable glands fitted to the lid
Cable glands fitted to the flat sides of the body

Note Side and lid entry can be used together but care needs to be taken that the lid and body parts can be fitted and then twisted together to complete the installation.

The WAGOBOX-Capsule lid has guide marks on its underside to show the centre positions for gland holes.

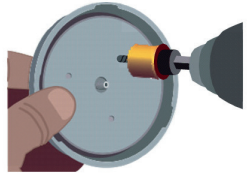

Gland holes on the sides of the WAGOBOX-Capsule must be positioned along the mid-line and spaced apart so adjacent lock nuts and washers can be fitted without interference.

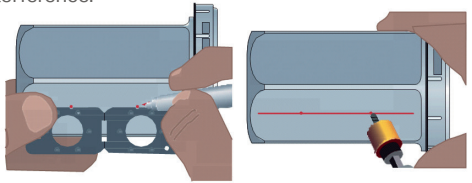

When using optional earth plates use the guide marks on the edge of the plates to mark the centre of the gland holes (ensure the small 2mm hole is nearest to the lid).

2. Fit the Glands to WAGOBOX-Capsule

Important Note: The WAGOBOX-Capsule is manufactured from an insulating material and does not require a connection to earth. When installing armoured cable the armoring will need to be earthed and may also be used as the Circuit Protective Conductor (CPC¹). Armoured cable used in conjunction with a WAGOBOX-Capsule requires the use of lid or side panel earth plates to ensure earth continuity.

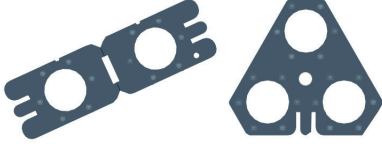

¹ Providing it meets all the relevant requirements eg. cross sectional area (csa).

The earth plates are fitted inside the WAGOBOX-Capsule and are held in place by the gland lock nut.

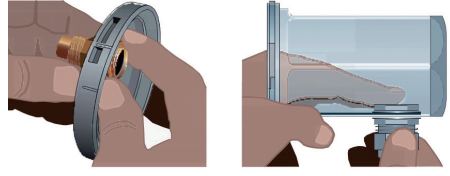

Note: the earth plates have connection points for push on terminals: These can be used to connect the earth of any equipment supplied by non-armoured cable.



Please refer to the manufactures fitting instructions for detailed guidance on installing glands.

3. Prepare Cables

Cables fitted to the sides of the of the WAGOBOX-Capsule base require sufficient cable length between the gland and the lid opening to allow cable connection outside of the enclosure.

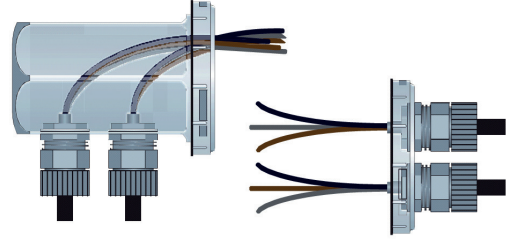

WAGOBOX Capsule from **CONNEXBOX**
www.connexbox.com

4. Select and Fit Terminals

The WAGOBOX-Capsule can be used with a range of WAGO electrical terminals.

773 Series		0.75 - 2.5mm ² Solid 1.5 - 2.5mm ² 7-Stranded 400V/4kV/24A
773-173		2.5 - 6mm ² Solid or 7-Stranded 400V/4kV/41A
2273 Series		0.5 - 2.5mm ² Solid only 450V/4kV/24A
222 Series		0.08 - 2.5mm ² Solid or 7-Stranded 0.08 - 4mm ² Fine-Stranded 400V/4kV/32A
221 Series		0.2 - 4mm ² Solid or 7-Stranded 0.14 - 4mm ² Fine-Stranded 450V/4kV/32A

5. Fit and Secure Lid

After connection, place cables and terminals in the WAGOBOX-Capsule. Check that the 'O'-ring seals in lid and capsule body are correctly positioned and clear of dirt and swarf. Twist lid clockwise to tighten and lock the lid in position. To ease the fitting of the lid silicone grease can be applied to the 'O' ring seals. The lid is locked when the black locking tab is fully visible. To unscrew the lid a small screw driver or WAGOBOX thumb tool must be used to depress the locking tab.

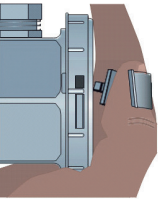
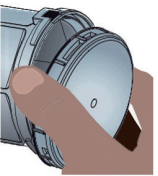

WAGO Limited
Triton Park, Swift Valley Industrial Estate, Rugby, Warwickshire, CV21 1SG
Tel: 01788 568 008 Fax: 01788 568 050 info@wago.ltd.uk www.wago.ltd.uk
WAGO is a registered trademark of WAGO Verwaltungsgesellschaft mbH