

Fitting Instructions for VARILIGHT®

Wiring Accessories

Please read these instructions carefully before beginning any electrical work and retain them for future reference. The product should be installed in accordance with the current addition of the IEE Wiring regulations. **If in doubt, consult a qualified electrician.**

1. Always switch OFF the mains supply and remove the appropriate fuse or switch off the appropriate circuit breaker before beginning electrical work.
2. Always use cable of the correct rating and type.
3. The layout of the terminals may differ between fittings so check the location of terminal connections carefully before wiring.
4. Make electrical connections according to the relevant diagram ensuring no bare wires protrude from the terminals.
5. If the product has an earth terminal connect the fixed earth wire to it and then connect a short length of wire from the earth terminal on the product to the earth terminal on the wall box. The earth wire should be sheathed with green and yellow sleeving.
6. Screw plate to wall using fixing screws supplied.
7. Switch on the mains supply.

! WARNING: Do not apply products with metal faceplates directly to freshly plastered or damp surfaces as product may tarnish. If in doubt, use polythene as a temporary gasket to protect the product. Do not use masking tape on metal faceplates.

EXAMPLE WIRING 1-WAY SWITCH

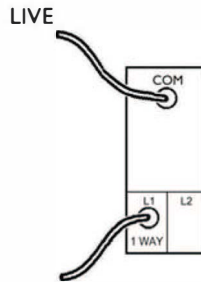

SWITCHED LIVE

For 2 or more gangs the live wire may be connected to each COM terminal by means of a short length of sleeved wire.

WIRING 2A, 5A, 13A SOCKETS

All sockets must be earthed and the earth leads adequately sleeved.

Connect the earth wire(s) to the terminal marked \perp

Connect the live wire(s) to the terminal marked L.

Connect the neutral wire(s) to the terminal marked N.

EXAMPLE WIRING 2-WAY SWITCHES

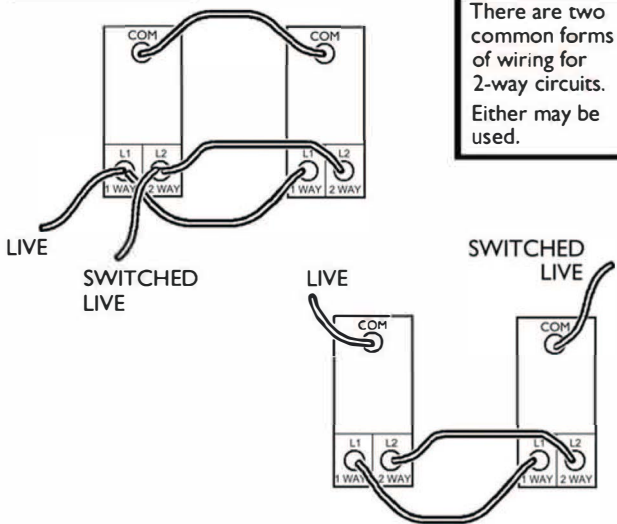

EXAMPLE WIRING DOUBLE POLE SWITCH

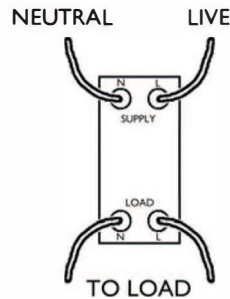

FAN ISOLATORS

Can be wired using the above configuration. The third pair of terminals should be used for fan units incorporating timers.

WIRING COAXIAL SOCKETS

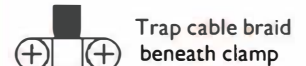

Screw central conductor into terminal

TELEPHONE SOCKETS

Master sockets should only be fitted by an authorised engineer.

When fitting a telephone slave as an extension, simply connect terminals 2, 3, 4 & 5 on the master unit to the same terminal number on the slave unit with the same cable colour.

EXAMPLE WIRING INTERMEDIATE SWITCH

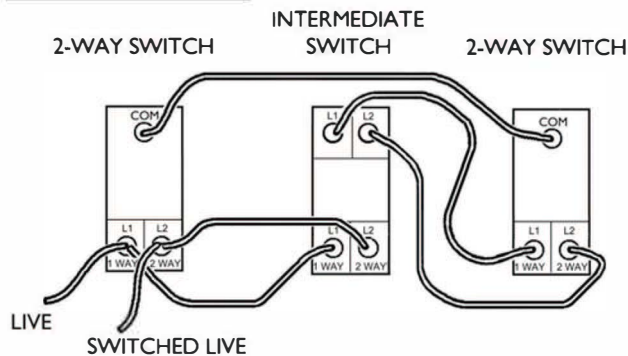

EXAMPLE WIRING FUSE HOLDER

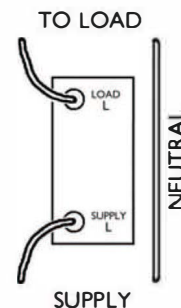

FUSE HOLDER USED WITH DOUBLE POLE SWITCH

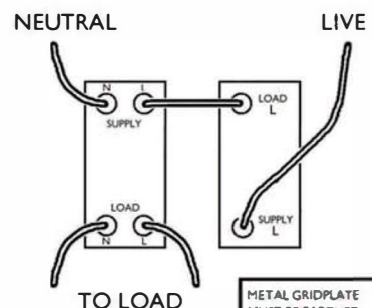

METAL GRIDPLATE MUST BE EARTHED USING THE TERMINAL PROVIDED

Guarantee: If this item becomes defective within 10 years of purchase, Varilight undertakes to repair or replace the item, at its discretion, and solely as a result of faulty materials or workmanship, provided that the unit has been correctly fitted according to the instructions, has not been used overloaded beyond its rating, tampered with or taken apart. Pack the unit securely and return it to: Service Department, Carylls Lea, Faygate, Horsham, West Sussex, RH12 4SJ (Tel. (01293) 223333), together with a letter stating the guarantee registration number below, the date and place of purchase, the type and wattage of the lighting or other load being controlled and the details of the fault. This guarantee states Varilight's entire liability, which does not extend to cover consequential loss or damage or installation costs arising from a defective product. This guarantee does not in any way affect the statutory rights of the purchaser and is offered so that you may have the benefit of our technical facilities.

Guarantee Registration Number: WA002

Recycling services for end-of-life electrical products should be offered by your local authority. Recycling services for metal faceplates may also be available in your locality.